

# UPS **MILITARY** **FIELD-GRADE**

UNINTERRUPTIBLE POWER SUPPLY

## Operator's Guide

**UPS-1250**

**DC Output Series**

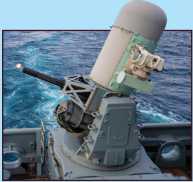

Made in USA

UPS-1250-1U



UPS-1250-2S



*N + M Redundancy*

**SynQor**<sup>®</sup>  
Advancing The Power Curve<sup>®</sup>

# Table of Contents

## SECTION I

## WARNINGS

<i>Hazardous Voltages</i> .....	4
<i>Hazardous Energies</i> .....	5
<i>Battery Pack</i> .....	6
<i>Protection from the Environment</i> .....	6
<i>User Serviceable Parts</i> .....	6

## SECTION II

## GENERAL PRODUCT INFORMATION

<i>Product Description</i> .....	7
<i>Product Topology</i> .....	8
<i>Part Numbering Scheme and Options</i> .....	10
<i>Electrical Characteristics</i> .....	11
<i>Product Specifications</i> .....	12
<i>UPS-1250-[S,H,M]-1U Mechanical Diagram</i> .....	13
<i>UPS-1250-[S,H,M]-2S Shallow Rack Mechanical Diagram</i> .....	14
<i>UPS Efficiency</i> .....	15
<i>Total Output Power that can be derived from the AC INPUT</i> .....	16
<i>Special Operating Temperature Conditions for the UPS-1250-S-2S “Shallow Rack”</i> .....	18
<i>Power Cable Wiring Diagram</i> .....	19
<i>Power Cable Wire Size</i> .....	20

## SECTION III

## OPERATION

<i>Set-Up</i> .....	22
<i>Start-Up</i> .....	23
<i>Shut-Down</i> .....	23
<i>Power Cable Connections/Disconnections While Operating</i> .....	24
<i>Cooling System</i> .....	25
<i>Front Panel Indicators</i> .....	26
<i>LEDs</i> .....	26
<i>Audible alarm</i> .....	31
<i>Hot Swapping the Battery Pack</i> .....	31
<i>Operating Environment</i> .....	32

## SECTION IV

## MULTIPLE UPS CONFIGURATIONS

<i>Parallel Connection of DC OUTPUTS – Parallel Option</i> .....	33
<i>N+M Redundancy - Ideal Diode</i> .....	33
<i>On/Off control – Parallel Systems</i> .....	34
<i>Connection of the AC INPUTS and/or DC INPUTS</i> .....	34
<i>3-Phase AC INPUT Source</i> .....	35

## SECTION V

## BATTERY PACK

<i>Battery Technology</i> .....	36
<i>Electronic Circuitry within the Battery Pack</i> .....	36
<i>Battery Capacity</i> .....	37
<i>Storage of the Battery Pack</i> .....	37
<i>Battery Pack Replacement</i> .....	37
<i>Handling the Battery Pack</i> .....	38

## SECTION VI

## CONTROL INTERFACE DETAILS

<i>Control Cable Connections</i> .....	39
<i>Internal User I/O Circuits</i> .....	40
<i>Remote On/Off Switch Connections</i> .....	40
<i>Digital Input/Output Control Signals</i> .....	41
<i>RS232 Serial Interface</i> .....	41
<i>Ethernet Interface</i> .....	43

## SECTION VII

## MAINTENANCE

<i>Battery</i> .....	44
<i>Fans</i> .....	44
<i>Cleaning</i> .....	44

## SECTION VIII

## TROUBLE-SHOOTING GUIDE

<i>Fault Conditions</i> .....	45
-------------------------------	----

## Hazardous Voltages

The **INPUT AND OUTPUT POWER** connectors and cables of the SynQor UPS may have voltages that are unsafe. **INJURY OR DEATH ON CONTACT** may result. Appropriate safety precautions should be taken. All connections should be made in accordance with **LOCAL ELECTRICAL CODES**.

- The UPS **CHASSIS** should be connected to earth or system ground with Ground Stud on the rear panel, see mechanical diagrams.
- For the **AC INPUT** cable and connector:
  - Do not assume that a hazardous voltage is not present at the terminals of the AC input connector, even if the UPS appears to be off.
  - Do not make contact with the terminals of the AC input connector.
  - Always connect the cable to the UPS before it is connected to the source of AC power.
  - Always disconnect the AC input cable from the source of AC power before disconnecting it from the UPS.
  - If the AC input cable is connected to the source of AC power and not connected to the UPS, do not contact the exposed terminals of the AC input cable.
  - Do not assume that the source of AC power is not present.
  - Connections between the AC input cable and the source of AC power should not be accessible.
- For the **DC INPUT** cable and connector:
  - The rated DC input voltage of the UPS is below the level considered hazardous.
  - The DC input terminals of the UPS are isolated from the AC input with reinforced safety insulation.
  - However, never assume the terminals of the DC input connector or the wires of the DC input cable are safe to contact, *even if the UPS or DC input source appears to be off*.
- For the **DC OUTPUT** cable and connector:
  - The rated DC output voltage of the UPS is below the level considered hazardous.
  - The DC output terminals of the UPS are isolated from the AC input with reinforced safety insulation.
  - However, never assume the terminals of the DC output connector or the wires of the DC output cable are safe to contact, even if the UPS appears to be off.
- For the **BATTERY PACK** (if not inserted into the UPS):

- When the battery pack is not inserted into the UPS, the battery is internally disconnected from the power pins of the battery pack's connector.
- Even if this disconnection were not present, the DC voltage of the battery is below the level considered hazardous.
- Do not apply external voltages to the pins of an exposed battery pack connector. It is not possible to charge the battery pack from an external source, and excess voltages could damage internal control circuitry.

### ***Hazardous Energies***

The **INPUT AND OUTPUT POWER** connectors and cables of the SynQor UPS may be the source of high levels of energy. Do not inappropriately make electrical contact between any terminal of a connector and another, or between any wire of a cable and another, or between any terminal or wire and the UPS's chassis or ground. **DAMAGING ELECTRICAL ARCS** may result. Care should be taken to avoid accidental electrical contacts of this sort.

When the **BATTERY PACK** is not inserted into the UPS, the battery is internally disconnected from the power pins of the battery pack's connector. An electrical contact between any two of these power pins or between any power pin and ground should therefore not be damaging. However, care should take to avoid accidental electrical contacts of this sort.

## Battery Pack

The individual **LITHIUM ION BATTERIES** contained in the SynQor battery pack are sealed units that are further mechanically protected by the battery pack's chassis and electrically protected by the battery pack's electronic circuitry. Under normal conditions they do not pose a hazard, but they should not be physically, thermally or electrically abused.

The **TRANSPORT** of the battery pack must comply with applicable regulations of the locality. See "Battery Pack - Handling the Battery Pack".

The battery pack should be **DISPOSED** in accordance with applicable regulations of the locality or **RETURNED** to a factory-authorized Service Center.

Emergency response contact information for battery damage, leaks, smoke, or fires can be found at the following link: <http://www.SynQor.com/UPS/documents/Contact.pdf>. Please contact the SynQor factory for all other questions regarding the UPS battery pack.

**CAUTION:** Do not dispose of batteries in a fire. The batteries may explode.

**CAUTION:** Do not open or mutilate batteries. Released electrolyte is harmful to the skin and eyes. It may be toxic.

Always use the proper SynQor battery pack. See the battery replacement chart on page 37.

## Protection from the Environment

The SynQor UPS is a ruggedly built product having its electronics and battery contained in sealed chambers. It is capable of withstanding harsh levels of mechanical acceleration, shock and vibration, temperature and pressure variations, and exposure to water, salt, sand and dust within the levels specified in the data sheet. **THESE LEVELS SHOULD NOT BE EXCEEDED.**

Do not obstruct the air intake in the front of the UPS or the fan exhausts in the rear panel of the UPS while the UPS is operating.

## User Serviceable Parts

UPS-1250 DC Output Series fans are user replaceable with kits available from SynQor. Please contact the SynQor factory for obtaining fan replacement kits and instructions (Replaceable Fan Module SYN-9450). The UPS-1250 DC Output Series has no other user serviceable parts inside of it. **DO NOT REMOVE** the cover of the unit or any of its connectors. Other than the fan assembly replacement, only factory trained personnel should perform repairs.

### *Product Description*

The SynQor UPS-1250 DC Output Series is an advanced technology military-grade uninterruptible power supply (UPS) that uses lithium ion batteries and highly efficient power electronic circuitry to achieve a high power level and battery run-time in a low-profile, low-weight, rack-mountable package. It provides voltage conditioning, electrical isolation, and power flow smoothing between the power inputs and its power outputs. It provides battery backed-up power when other power sources are not present.

A communication/control port is available to permit monitoring and control by a host computer system. Front panel LEDs and an audible alarm provide information on the status of the UPS and the battery pack.

The UPS provides up to 1250 W of DC output power at a nominal 24 V, 28 V or 48 V depending on which model is selected.

The electronic circuitry within the UPS-1250 DC Output Series products is designed, qualified and screened according to SynQor's MIL-COTS Standards. It complies with the requirements of MIL-STD-704F, MIL-STD-1399-300B, MIL-STD-1275D and MIL-STD-461F, as well as IEC-EN61000 specifications for world-wide commercial utility applications.

The UPS-1250 DC Output Series products are designed and manufactured to withstand the harsh environments and use encountered in military applications. The electronic circuitry and battery are contained in a sealed chamber constructed from a die-cast aluminum chassis that is weather-proof and shock-proof. Redundant, water-proof fans on the rear panel draw cooling air over the heat-sink fins below the sealed chamber. Military-grade circular connectors are used, and optional attached connector covers are available for when the cables are not attached. The UPS-1250 DC Output Series products comply with a wide range of testing according to MIL-STD-810G.

The UPS-1250 DC Output Series has two product formats: 1) a 1U high unit that has a standard battery pack that provides >10 minutes, >13.5 minutes or >16 minutes of full-power run-time, 2) a 2U high, shallow-rack unit that has a standard battery pack that provides >10 minutes, >13.5 minutes or >16 minutes of full power run time.

The SynQor UPS-1250 DC Output Series products are designed and manufactured in the U.S.A.

### Product Topology

The SynQor UPS-1250 DC Output Series products use a true on-line double conversion topology that provides protection to the load from spikes, noise, surges, brownouts, blackouts, etc. in the input power sources. They also provide smoothing of load transients and nonlinear load profiles so that the input power sources are not subjected to these disturbances. There is a seamless transfer from any power source to another so that there is no disruption in the output voltage waveform.

As the figure below shows, there is a nominal 28 V mid-bus within the UPS that draws power from one of up to three power sources: the AC INPUT, the DC INPUT or the battery (with that order of priority based on availability). EMI filters are present at all external inputs and outputs.

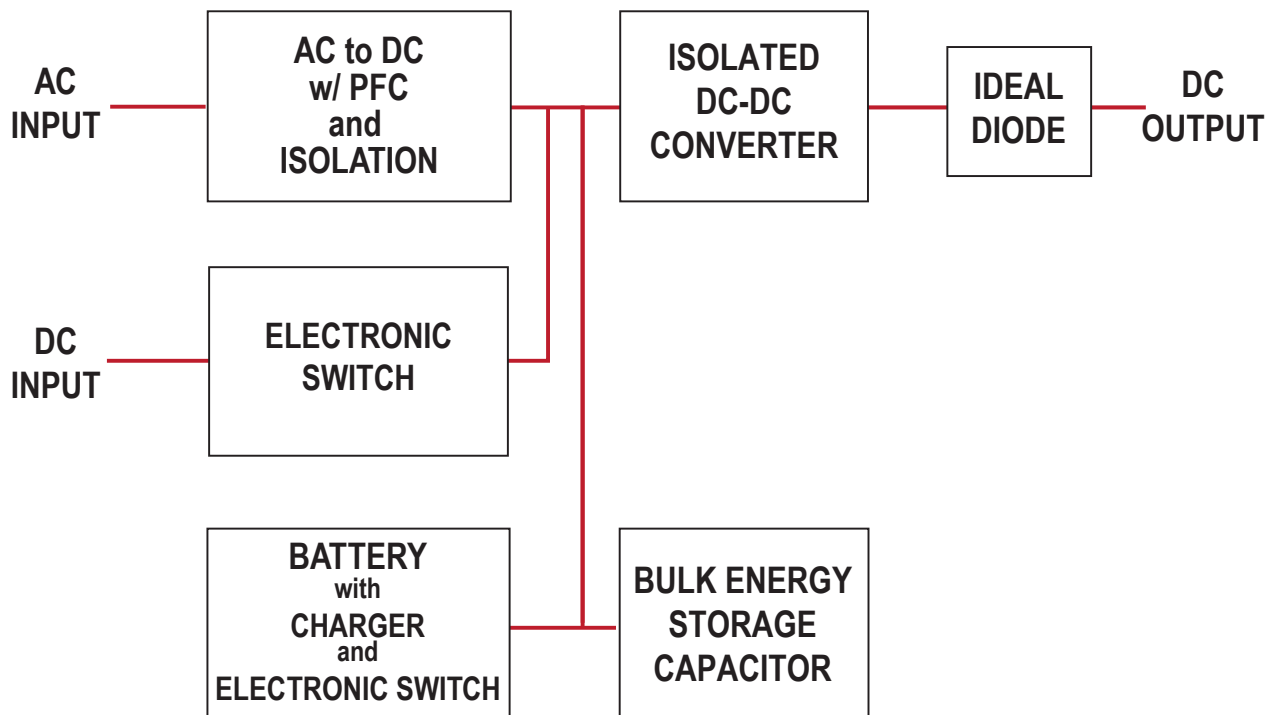

Power flows from the AC INPUT through an AC-DC converter that has Power Factor Correction (PFC) and high-frequency safety isolation. Power flows from the DC INPUT through an electronic switch that is closed when the AC INPUT power is absent and the DC INPUT voltage is within its specified range. Otherwise, a second electronic switch is closed to connect the battery to the mid-bus.

The DC output can deliver up to 1250 W. The DC output is isolated from the AC input.



Bulk energy storage capacitors are connected to the mid-bus to help smooth imbalances in power flow between the inputs and output of the UPS.

There is a battery charger circuit that draws power from the mid-bus. It ensures the batteries are normally fully charged and that the various cells are equalized. The battery also contains protection circuitry to avoid damage due to improper charging or discharging, or to excessive temperatures.

There is a communication/control port that provides a digital interface to a host computer system.



**UPS in Transit Case Option**

**Part Numbering Scheme and Options**

This table shows the part numbering scheme for the full line of SynQor UPS products:

DC Base Models				
Model Number	Power	Battery Run-Time @Full Power (80% Power)	Height (W x D x H)	Weight
UPS-1250-S-1U (1 Standard Battery Pack)	1250 W	>10 min. (>13 min.)	1U (17" x 22.25" x 1.73")	33 lbs.
UPS-1250-H-1U (1 Standard Battery Pack)	1250 W	>13.5 min.(>18 min.)	1U (17" x 22.25" x 1.73")	34.8 lbs.
UPS-1250-M-1U (1 Standard Battery Pack)	1250 W	>16 min. (>22 min.)	1U (17" x 22.25" x 1.73")	34.8 lbs.
UPS-1250-S-2S (1 Standard Battery Pack)	1250 W	>10 min. (>13 min.)	2U (17" x 13.80" x 3.40")	33 lbs.
UPS-1250-H-2S (1 Standard Battery Pack)	1250 W	>13.5 min.(>18 min.)	2U (17" x 13.80" x 3.40")	34.8 lbs.
UPS-1250-M-2S (1 Standard Battery Pack)	1250 W	>16 min. (>22 min.)	2U (17" x 13.80" x 3.40")	34.8 lbs.

Base Model	Options				
	AC Input Frequency	DC Regulation Type	DC Output Voltage	DC Input	Additional Options
UPS-1250-S-1U- UPS-1250-H-1U- UPS-1250-M-1U- UPS-1250-S-2S- UPS-1250-H-2S- UPS-1250-M-2S-	L W	R P	48 28 24	D00	-E    00 CE

Options	
AC Input Frequency	L 47-65 Hz W 47-800 Hz
DC Regulation	R Fully Regulated, No Paralleling P Fully Regulated with Paralleling
DC Output	48 48 V Output 28 28 V Output 24 24 V Output
DC Input	D00 DC Input
Additional Options	-E Ethernet/SNMP with Configuration Loading 00 No CE Marking CE CE Marking

Not all combinations make valid part numbers, please contact SynQor for availability.  
**Examples: UPS-1250-S-1U-LR28D00-E00, UPS-1250-S-2S-WR28D00-ECE**

The UPS-1250 DC Output Series of products provide up to 1250 W of total output power (DC). They come in two different physical formats:

- A 1U high, 33 lb. and 34.8 lbs. rackmount unit that uses the standard battery pack that provides >10 minutes, >13.5 minutes or >16 minutes of battery run-time at full power
- A 2S high, 33 lb. and 34.8 lbs. shallow rackmount unit that uses the standard battery pack that provides >10 minutes, >13.5 minutes or >16 minutes of battery run-time at full power

Each format has various options that can be specified according to the part numbering scheme shown in the table:

- The allowable frequency of the AC INPUT can either be in the 47-65 Hz range (for 50 Hz and/or 60 Hz systems) or in the 47-800 Hz range (for 400 Hz and Variable Frequency systems)
- The output voltage of the UPS-1250 DC Output Series can be 24 V, 28 V, or 48 V nominal.
- There is a DC INPUT that is specified to comply with MIL-STD-704F and MIL-STD-1275D for 28 V systems.
- RS232 serial port and logic-level I/O communication are included in the standard model. An Ethernet port providing web and SNMP interfaces is in the standard model.

## Electrical Characteristics

### INPUT CHARACTERISTICS

#### Operating AC Input

Voltage	80-265 Vrms*
Frequency	47-65 Hz (47-800 Hz Optional)
Input Power Factor	>0.98 at 47-65 Hz >0.97 at 400 Hz >0.93 at 800 Hz
Maximum Input Current Continuous	20 A (full load, 85 Vrms)
AC Input Circuit Breaker Rating (* Power Derating to 80% below 90 Vrms)	25 A

#### Operating DC Input

Voltage	22-33 V
Continuous Maximum Input Current	62 A (full load, 22 V)
Transient Maximum Input Current	75 A

### OUTPUT CHARACTERISTICS

Output Power Continuous	1250 W
Voltage Setpoint Accuracy	± 3%
Voltage Regulation (Over Load & Temperature) ± 5%	

#### DC Output - Fully Regulated

##### 48V Option

Voltage Setpoint (Nominal)	48 V
Operating Output Current Range	0 - 26 A
Overload Current Maximum ( < 1 sec)	45 A

##### 28V Option

Voltage Setpoint (Nominal)	28 V
Operating Output Current Range	0 - 45 A
Overload Current Maximum ( < 1 sec)	60 A

##### 24V Option

Voltage Setpoint (Nominal)	24 V
Operating Output Current Range	0 - 52 A
Overload Current Maximum ( < 1 sec)	60 A

### RELIABILITY CHARACTERISTICS MIL-HDBK-217F

MTBF	100 kHrs	MIL-217F Ground Benign, Ta=25 °C
------	----------	----------------------------------

### ELECTROMAGNETIC CAPABILITY MIL-STD-461F

CE101**	30 Hz - 10 kHz
CE102	10 kHz - 10 MHz
CS101	30 Hz - 150 kHz
CS106	Pulse Transient
CS114	10 kHz - 200 MHz
CS116	10 kHz - 100 MHz
RE101	30 Hz - 100 kHz
RE102	10 kHz - 18 GHz
RS101	30 Hz - 100 kHz
RS103	2 MHz - 40 GHz

\*\* Regarding MIL-STD-461 CE-101, the 50 uH series inductance of a standard LISN adversely affects the input ripple of the UPS (DC input only). Such a large series source inductance (50 uH in each power lead) is not generally encountered in a 28 V DC source of such high power rating. Therefore, testing for CE-101 (DC input) was conducted with 3 different configurations: two using 50 uH LISNs and a 54 mF capacitor connected across the input to the UPS, and one using 5 uH LISNs for which no additional capacitor was added.

These configurations all passed CE-101 for all frequencies.

\* Limited to +50 °C by battery pack. See Operator's Guide for details.

Specifications subject to change without notice.

### MECHANICAL CHARACTERISTICS

#### UPS-1250-S-1U (Standard Battery Pack)

Chassis Width	17"W
Chassis Depth	22.25"D
Chassis Height	1.73"(1U)H
Case Material	Aluminum
Total Weight	33 lbs. (with chassis & battery)

#### UPS-1250-S-2S (Shallow Rack, Standard Battery Pack)

Chassis Width	17"W
Chassis Depth	13.80"D
Chassis Height	3.40"(2U)H
Case Material	Aluminum
Total Weight	33 lbs. (with chassis & battery)

#### Cooling Exhaust Fans

Sound Pressure Level (SPL)	54 dB(A)
Air Flow	0.67(m <sup>3</sup> /min) 23.7 CFM

Two fans in system, above specs are for each fan separately.

### MECHANICAL CONNECTORS

#### Connectors

AC Input Connector	MS3470L14-4P
User I/O Ports	HD DB15 Female
Configuration I/O Port	HD DB15 Male
Ethernet Port	Amphenol RJF22N00, Code B
DC Input Connector	MS3470L18-8P
DC Output Connector	MS3470L18-8S

### ENVIRONMENTAL CHARACTERISTICS MIL-STD-810G

#### Operating Temperature (Methods 501.5, 502.5)

UPS-1250-S-1U	-20 °C to +55 °C
UPS-1250-S-2S From DC Input	-20 °C to +55 °C
UPS-1250-S-2S From AC Input*	-20 °C to +50 °C

#### Non-Operating Temperature

All Models	-40 °C to +65 °C
------------	------------------

#### Altitude Method 500.5

Operating	0 - 18,000 ft
Non-operating	0 - 40,000 ft

#### Environmental Tests

Shock/Drop	Method 516.6, Procedures 1,4,6
Temperature Shock	Method 503.5, Procedure 1
Vibration	Method 514.6, CAT 5, 7, 8, 9, 24
Fungus	Method 508.6
Salt Fog	Method 509.5
Sand and Dust	Method 510.5, Procedures 1,2
Rain	Method 506.5 Procedure 1
Humidity	Method 507.5 Procedure 2
Mechanical Vibrations of Shipboard Equipment	Method 528 Procedure 1

**Product Specifications**

The following three pages show the electrical and mechanical specifications of the UPS-1250-S-1U, UPS-1250-S-2S, and the UPS-1250-E-2U Series of products. Data sheets showing these specifications and other information can be found at the web site. <http://www.synqor.com/UPS>



**UPS-1250-1U with DC & AC Input/DC Output**

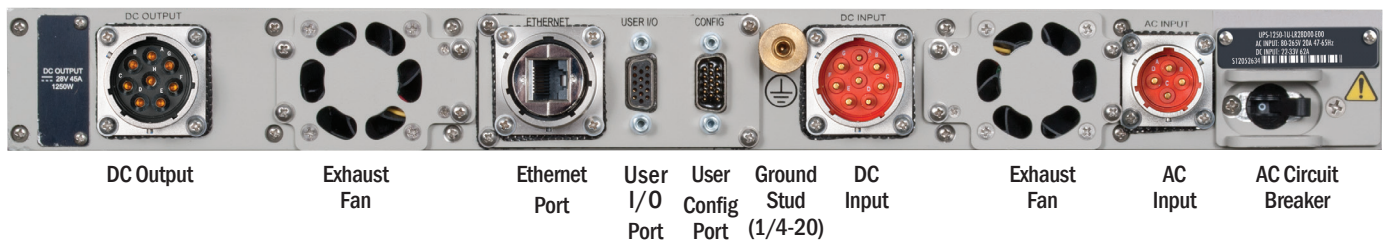

**UPS-1250-2S**

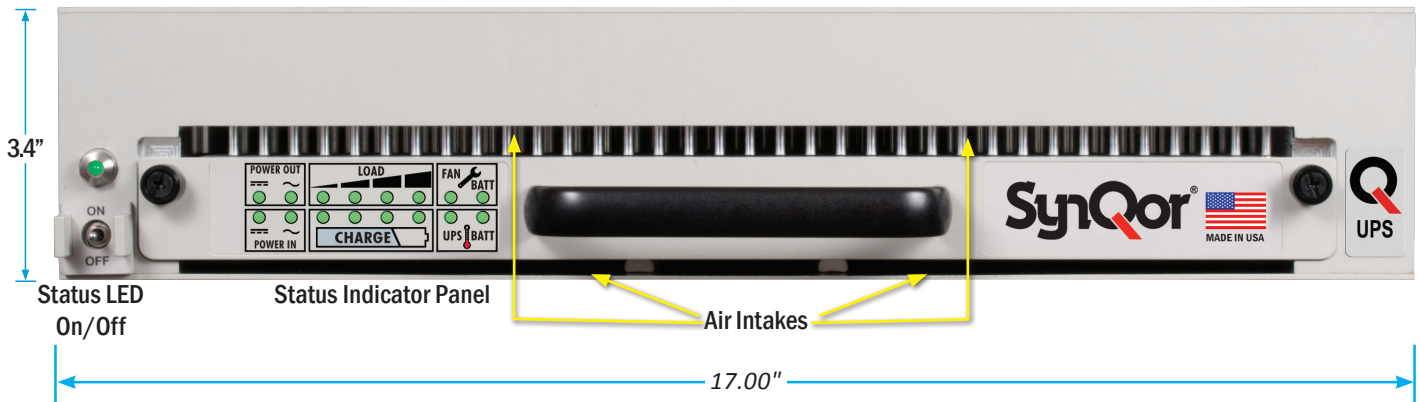

**UPS-1250-2S Unit with AC & DC Input / DC Output**

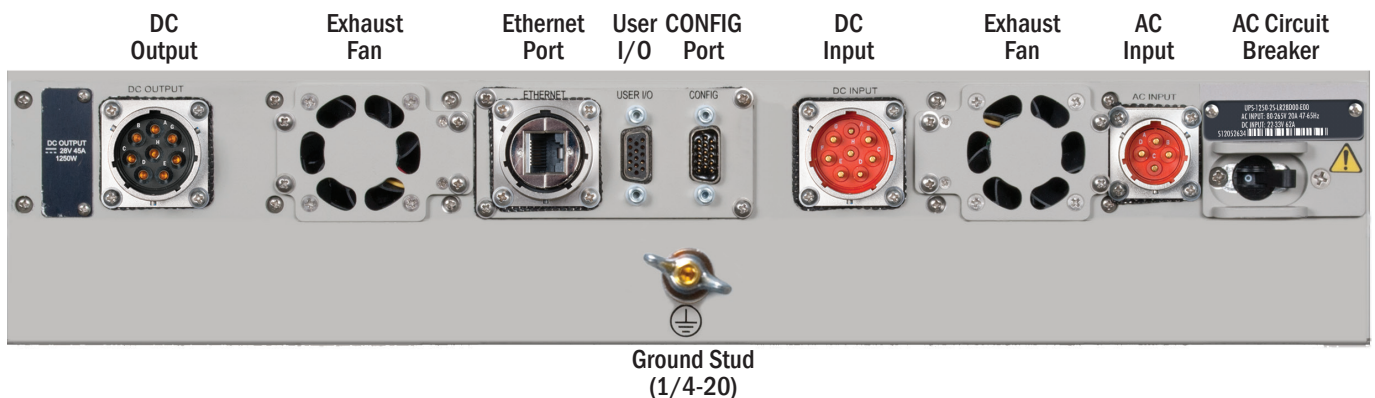

**UPS-1250-[S,H,M]-1U Mechanical Diagram**

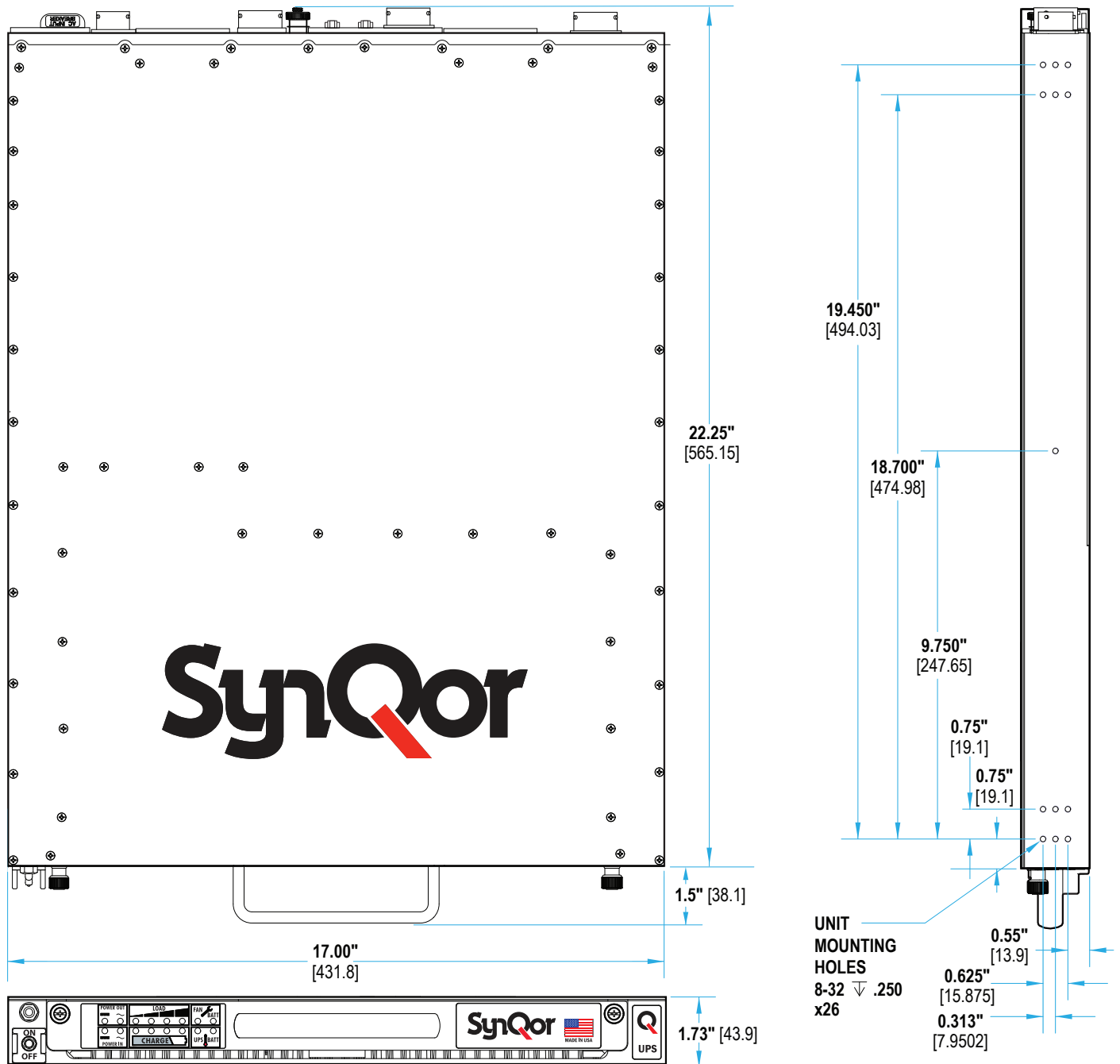

**UPS-1250-[S,H,M]-2S Shallow Rack Mechanical Diagram**

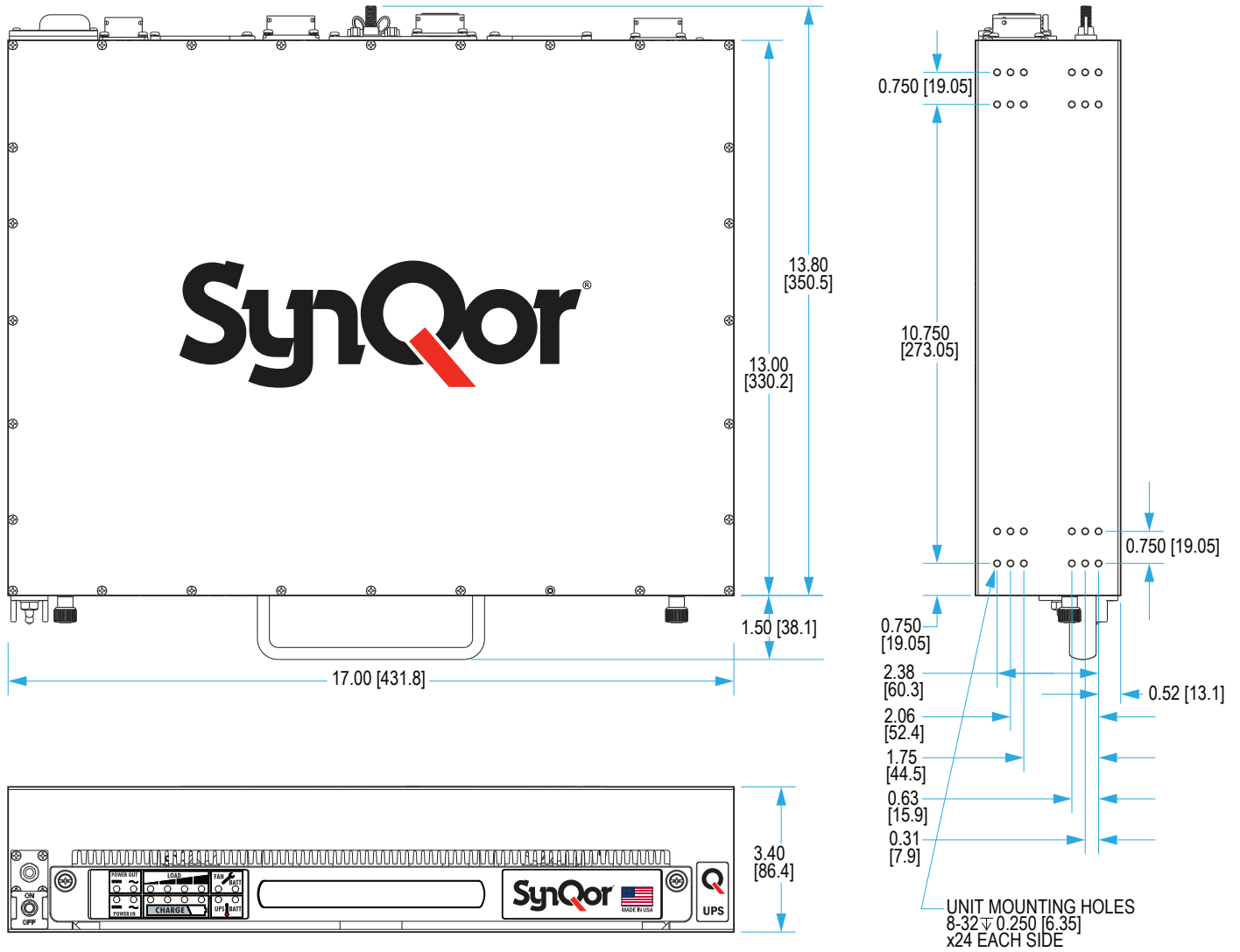

**UPS Efficiency**

Figure 1 shows the typical efficiency with which the UPS-1250 DC Output Series uninterruptible power supplies delivers power to its DC OUTPUT from a 22, 28, and 33 volts input.

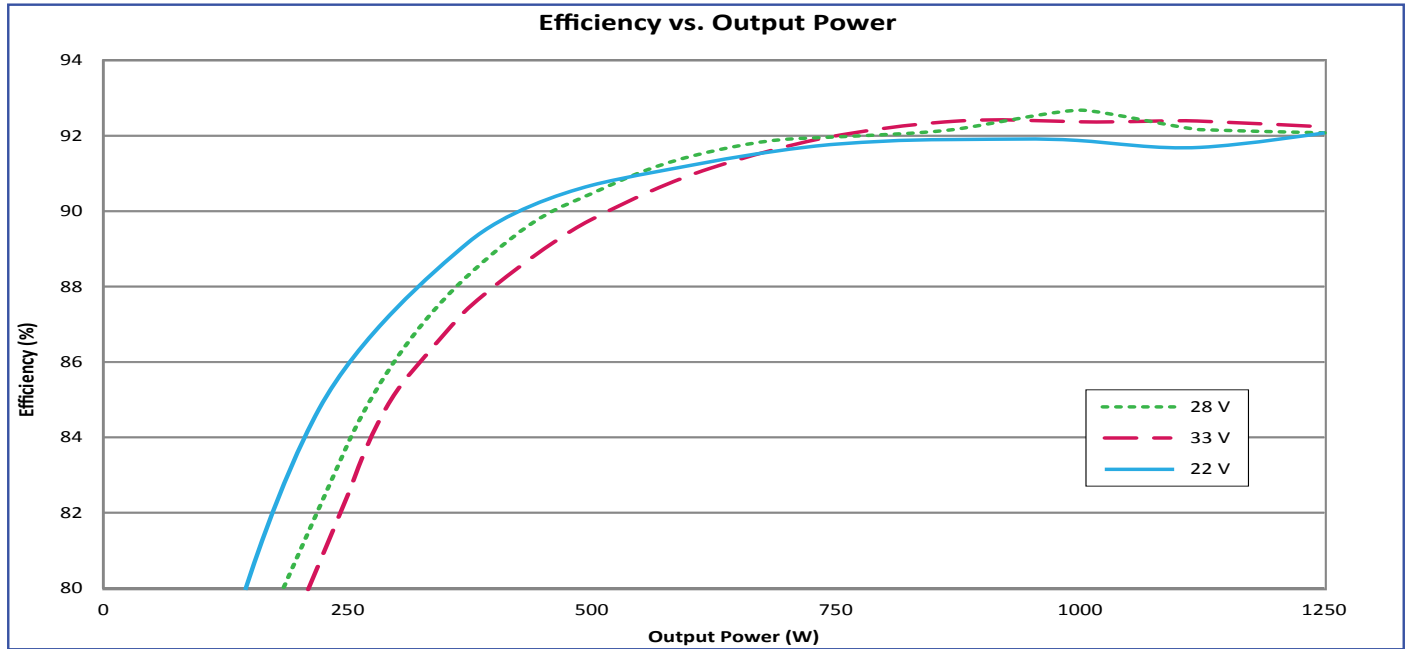

Figure 1

Figure 2 shows the typical efficiency with which the UPS-1250 DC Output Series uninterruptible power supplies delivers power to its DC OUTPUT from 115 VAC and 230 VAC input.

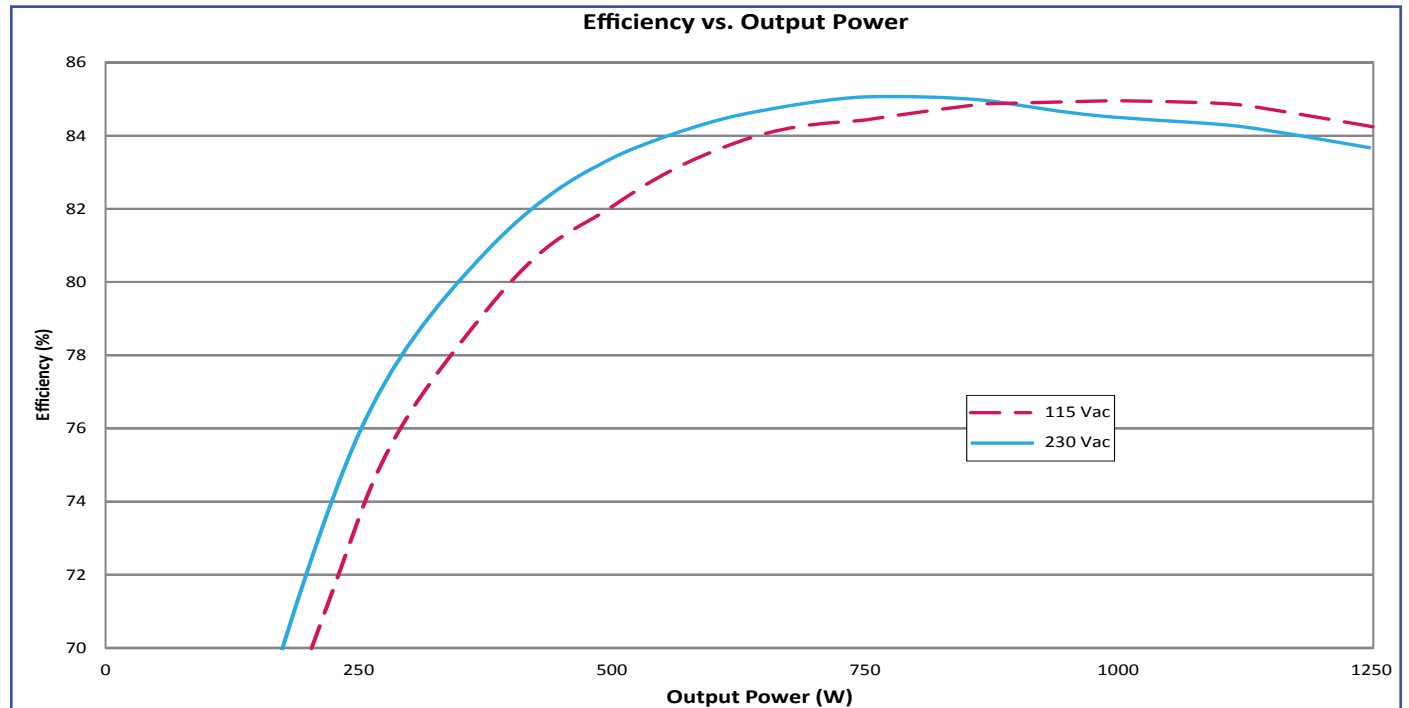

Figure 2

### *Total Output Power that can be derived from the AC INPUT*

The total UPS output power for the UPS-1250 DC Output Series is rated at 1250 W for an ambient temperature as high as 55°C (131°F). It draws this power first from the AC INPUT (if its voltage is within range) and then the DC INPUT (if its voltage is within range) and then from the internal BATTERY PACK (if it has sufficient charge).

However, when the AC INPUT voltage is at the low end of its range (<90 Vrms) or the ambient temperature is at the high end of its range (>45°C/113°F) the UPS will not be able to deliver its full rated output power in the steady-state without switching over to either the DC INPUT (if it is available and >22 Vdc) or its internal battery. Figure 4 indicates the total steady-state output power that the UPS can derive **from the AC INPUT** under these extreme conditions. See Figure 3 for information on transient conditions.

- If the AC INPUT voltage is above 105 Vrms, then the UPS can deliver its full rated output power of 1250 W from the AC INPUT for an ambient temperature as high as 55°C (131°F) without needing to switch over to the optional DC INPUT or the internal BATTERY PACK.
- If the AC INPUT is between 90 Vrms and 80 Vrms then the total output power that can be derived from the AC INPUT linearly decreases from 1250 W at 90 Vrms to 1000 W at 80 Vrms (except for at the high end of the ambient temperature range – see below). For example, the total output power that could be derived from the AC INPUT would be 1125 W at 85 Vrms as long as the ambient temperature is not above 50°C (122°F). If the total output power is greater than this derated value, the UPS will switch to the DC INPUT (if it is available and >22 V) or the internal BATTERY PACK.
- If the AC INPUT voltage is 90 Vrms **AND** the ambient air temperature is above 45°C (113°F), the total output power that can be derived from the AC INPUT linearly decreases from 1250 W at 45°C (113°F) to 1000 W at 55°C (131°F). For example, the total output power that could be derived from the AC INPUT would be 1125 W at an AC INPUT voltage of 90 Vrms and an ambient temperature of 50°C (122°F). A higher output power than this would cause the UPS to switch over to its DC INPUT or the internal BATTERY PACK.
- When the AC INPUT voltage is between 105 Vrms and 90 Vrms **AND** the ambient temperature is between 45°C and 55°C, the total output power that can be derived from the AC INPUT can be calculated by linearly interpolating between the curves shown. For example, the total output power that can be derived from the AC INPUT when the voltage is 97.5 Vrms would be 1250 W up to an ambient temperature of 50°C (122°F) and then derate to 1125 W at 55°C (131°F).

Furthermore, there is a limited (and uncommon) range of AC INPUT voltage between 132 Vrms and 160 Vrms in which the total output power that can be derived from the AC INPUT is also derated, as shown in Figure 3.



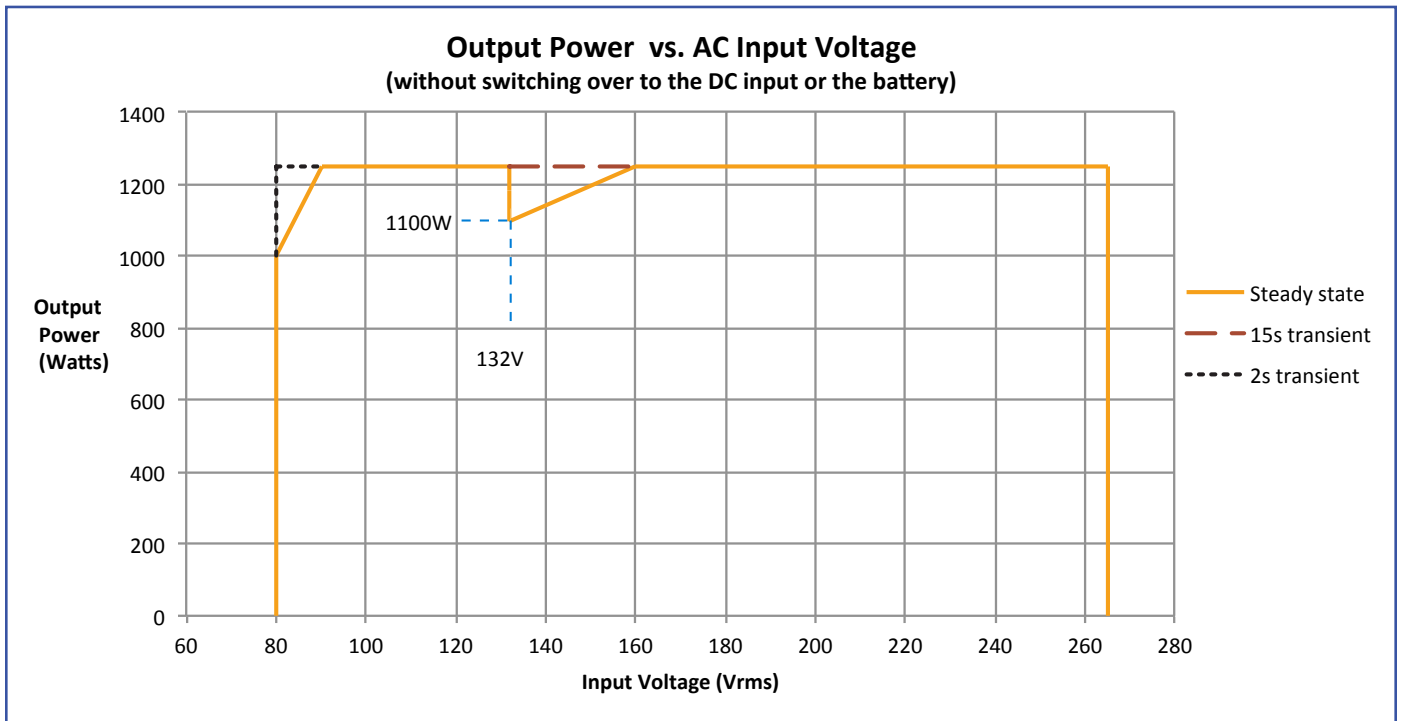

Figure 3

Note that the full rated output power of 1250 W can be derived from the AC INPUT having a voltage within this uncommon range for 15 seconds before the UPS will switch over to the DC INPUT or the BATTERY PACK. Also note that the UPS can drive it full rated power for a 2 second interval even if the AC INPUT voltage drops below 90 Vrms.

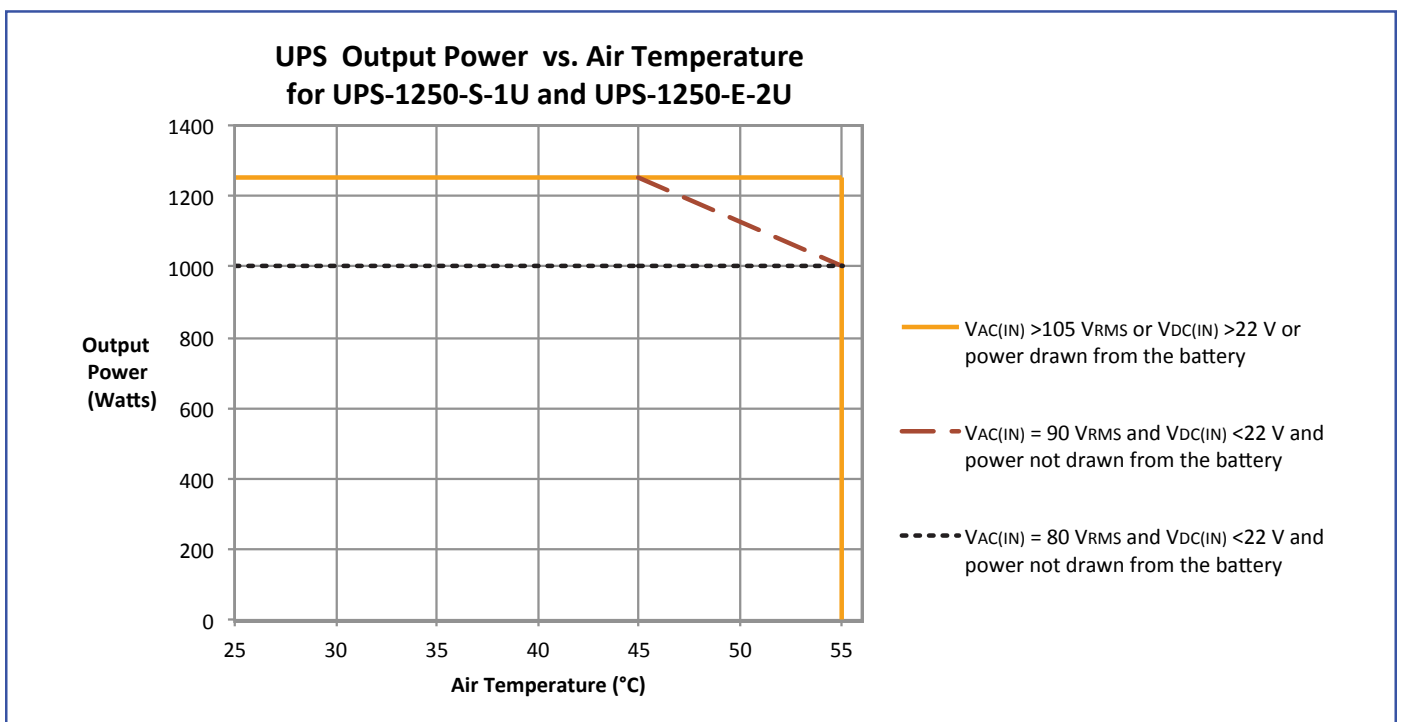

Figure 4

**Special Operating Temperature Conditions for the UPS-1250-S-2S “Shallow Rack”**

The UPS-1250-S-2S “Shallow Rack” model has a different forced convection cooling system than the other models in the UPS-1250 family. Depending on the type of input power source, the UPS-1250-S-2S has two different maximum temperatures ratings. For an AC input source, the maximum operating temperature is 50 °C. Operating the UPS-1250-S-2S “Shallow Rack” above 50 °C when powered from an AC source or 55 °C when powered from a DC source may result in a reduced or zero backup battery runtime.

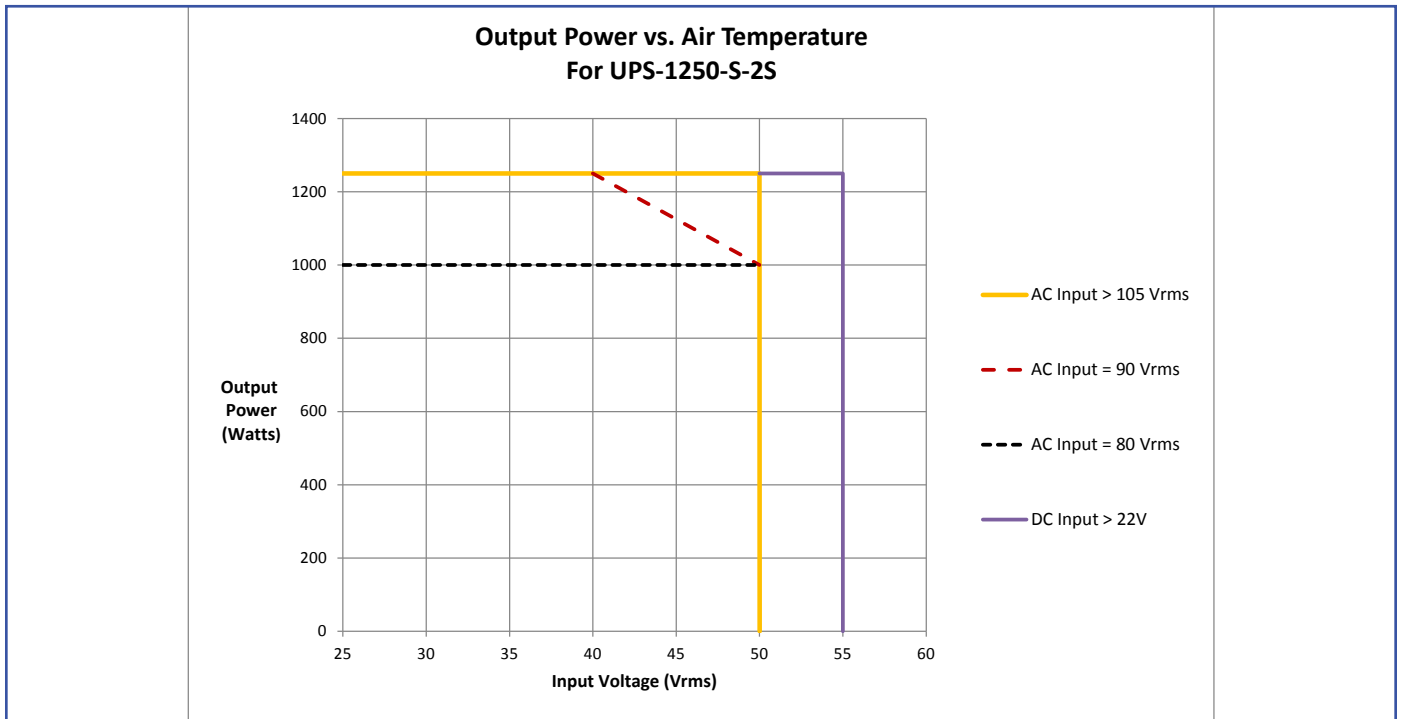
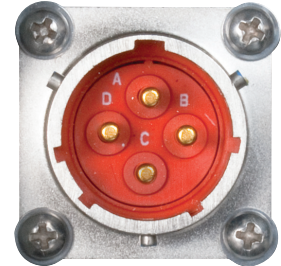
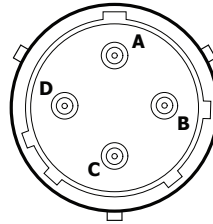

Figure 5

**Power Cable Wiring Diagram**

Looking at the rear panel, the UPS connector terminals have the following functions and locations:

AC INPUT	
Pin	Function
A	Line
B	Neutral
C	No Connect
D	Ground



DC INPUT	
Pin	Function
G, F, E	+V <sub>IN</sub>
B, C, D	V <sub>IN</sub> Return
A, H	No Connect

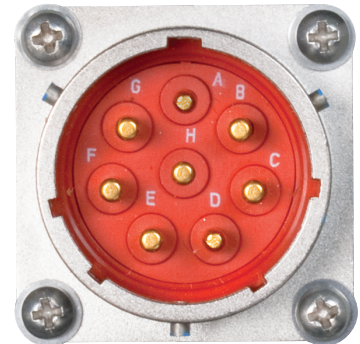
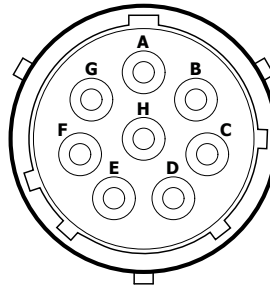

DC OUTPUT	
Pin	Function
G, F, E	+V <sub>OUT</sub>
B, C, D	V <sub>OUT</sub> Return
A, H	No Connect

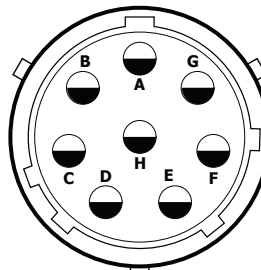

### Power Cable Wire Size

SynQor recommends the following cables for use with the UPS-1250 DC Output Series:

- AC Input: SYN-9101 UPS connection to NEMA 5-20 Plug, 10'
- SYN-9104 UPS connection to NEMA 5-15 Plug, 10'
- SYN-9102 UPS connection to Hardwire Termination, 10'
- DC Input: SYN-9151 UPS connection to Ring Connectors, 10'
- SYN-9154 UPS connection to NATO Connector, 10'
- DC Output: SYN-9174 UPS connection to Harwire Termination, DC Output, 10'
- SYN-9175 UPS connection to Fork Connectors, DC Output, 10'

Other options may be available. Contact [info@synqor.com](mailto:info@synqor.com) or visit the website: <http://www.synqor.com> for more information. If it is necessary to develop custom cables for your application, please read through the following section for some important considerations. Damage caused by improper wiring of cables will not be covered under SynQor's warranty.

Both the input and output cables of the UPS carry substantial current, and since the wires in these cables have resistance the current flowing through them causes a voltage drop from one end of the cable to the other. In other words, the voltage across the cable at its downstream end is smaller than the voltage across the cable at its upstream end. Mathematically, the amount that the voltage drops is equal to the resistance of the cable's wire multiplied by the current flowing through the wire. It is therefore **important** to make sure that the **resistance of the cable's wire is small** enough to keep this voltage drop to an acceptably small value.

While this is an issue for all of the power cables, **it is particularly important for the DC INPUT and DC Output cables** because the current flowing through it is very high (as high as 65 A for the UPS-1250 DC Output Series) and the voltage across it is already relatively small (as low as 22 V). In fact, a common problem that arises (when the DC INPUT cable has too small a wire) is that the voltage seen at the DC INPUT of the UPS falls below the minimum specified value of 22 V even though the voltage at the source of the DC power is greater than 22 V. Under this condition the UPS will switch to the internal battery pack for its power source even though the voltage at the DC source of power appears to be available and at a proper level.

The resistance of a wire depends directly on its length. A wire twice as long as another will have twice the resistance, holding all other things constant. The resistance also depends on the reciprocal of the cross-sectional area of the wire, which in turn depends on the square of the wire's diameter. A wire with half the diameter of another will therefore have four times the resistance, holding all other things constant.

Therefore, the longer a cable is, the more important it is that the wire's diameter be large. Alternatively, a cable can have multiple pairs of wires to achieve a larger "effective wire diameter".

This second approach gives a more flexible cable. For 10 ft long cables, SynQor recommends that for the UPS-1250 DC Output Series:

- The AC INPUT cable has 3 wires (one for the ground) of 12 AWG
- The DC INPUT cable has 6 wires (three for each connection) of 12 AWG
- The DC OUTPUT cable has 6 wires (three for each connection) of 12 AWG

Additional details about the effects of a resistance-related voltage drop are included in “Trouble-Shooting Guide - Cable wire resistance is too high”.

## Set-Up

The recommended procedure for setting up the UPS is the following:

- Insert the BATTERY PACK (if not already present) and tighten its screws.
- Make sure the AC BREAKER on the rear panel of the UPS is in the OFF position.
- Connect the ground wire to the ground stud on the rear panel of the UPS.
- Connect all OUTPUT cables, first to the UPS and then to the various loads.
- **VERIFY** that the DC OUTPUT cable is connected to the UPS and the load with the correct polarity.
- Connect the USER I/O cables.
- Connect all INPUT cables, first to the UPS and then to the various sources.
- An overcurrent protect and disconnect device should be installed on the DC INPUT circuit. An example of a suitable device is a Carling Technologies, C-series, 80 A 65 VDC, CA1-B0-14-680-321-J circuit breaker. ([www.carlingtech.com](http://www.carlingtech.com))
- **VERIFY** that the DC INPUT cable is connected to the UPS and the source of DC power with the correct polarity.
- Turn on the sources (if they have an upstream breaker).
- Move the AC BREAKER on the rear panel of the UPS to the ON position.

**Note:** Be careful to not toggle the ON/OFF switch during the setup. Doing so could cause the UPS to turn on and present a hazardous voltage at its output.

### Start-Up

- **VERIFY** that all connections to the UPS are correct.
- If either the AC source or the DC source (or both) is present and within specifications, the color of the LED above the ON/OFF switch will be amber. This indicates that the UPS is in standby mode and ready to turn on. The battery pack LEDs will also be appropriately illuminated.
- Momentarily push the ON/OFF switch on the front panel of the UPS upward. The switch can then be released and it will return to its normal (neutral) position.
- The UPS will immediately enable its output (assuming there is no fault condition). The color of the LED above the ON/OFF switch will change to green. The LEDs on the battery pack will indicate the amount of power being delivered to the load and the input source from which this power is being drawn.

**Note:** If no input power sources are available the UPS can still be turned on. It will draw power from the internal battery for as long as the battery has charge left in it. This is sometimes referred to as a “COLD START” in the industry. Under this condition, the LED above the ON/OFF switch and the battery pack’s LEDs will initially all be off. When the ON/OFF switch is pushed to the ON position, all of these LEDs will be appropriately illuminated.

### Shut-Down

- Shut down the equipment connected to the UPS.
- Push the ON/OFF switch on the front panel of the UPS downward and hold it in this position for 1 second (or more). The color of the LED above the ON/OFF switch will change to amber (if one or both input power sources are present) or it will be off (if no power sources are present). The switch can then be released to return to its normal position.
- The UPS will disable its output and shut down.
- The battery pack LEDs will either be appropriately illuminated (if one or both input power sources are present) or they will be off (if no power sources are present).
- It is not necessary to move the AC BREAKER on the rear panel of the UPS to the OFF position.

### Power Cable Connections/Disconnections While Operating

**For safety reasons, it is highly recommended** that the input and output power cables be connected to the UPS before the source of AC or DC input power is turned on, and before the UPS is turned on (see **Section I: Warnings** and the **SET-UP** section above). Similarly, it is **highly recommended** to first turn off the UPS and the sources of input power before any power cables are disconnected from the UPS.

However, the SynQor UPS is capable of having any of its input or output power cables connected at any time (if safely done), including when the UPS is turned on and delivering power to the load. For instance:

- Even if the UPS is turned on, one can connect or disconnect the input power cables without harming the UPS or disrupting power delivery to the load. If no input power source is available, the UPS will draw power from the battery pack. When there is an external source of power connected to the UPS, the unit will draw power from that source, choosing the AC INPUT source first, if present, and then the DC input source. The transfer from one source of power (including the battery) to another is seamless.
- Even if the UPS is turned on, one can connect or disconnect an output power cable without harming the UPS or disrupting power delivery to a load that might be connected to the other output.

**NOTE** that disconnecting an input or output power cable while that cable is handling power will likely cause an arc to form as the terminals are pulled apart. This arcing is not harmful to the UPS, although if done enough times it will degrade the connector to the point where it will need to be replaced. This problem is particularly acute for the **DC INPUT cable** because its current is so high. Disconnecting this cable while a large current is flowing is **not recommended**.

**ALSO NOTE** that when the UPS is turned on and delivering power to a load, and then another piece of equipment is connected to the same output, it is possible that this connection will momentarily disrupt the quality of the UPS's output voltage. If the UPS is turned on and delivering power to several loads and then another load is connected, it is possible that this new load will momentarily draw a large surge of current as it starts up. If this happens, the output of the UPS could reach its maximum current limit, and the UPS will reduce its output voltage to keep the current from getting any larger. This reduction in voltage will be corrected once the new load reaches its normal mode of operation, but in the mean time the reduction of the UPS's output voltage might cause one or more of the other loads to malfunction. Whether or not this will be a problem depends on the characteristics of the various loads.



## Cooling System

The SynQor UPS-1250 DC Output Series products are cooled by fans that draw air into the intake below the battery pack on the front panel and exhaust it out the two fan ports on the rear panel. Care should be taken to ensure there is no obstruction to this airflow, either at the front intake or the rear exhaust ports. Similarly, care should be taken to avoid obstructing the fan blades.

The speed of the cooling fans is automatically controlled to provide adequate UPS cooling while extending the life of the fan bearings. Under low ambient temperature and/or low UPS output power the fans will be driven at a low speed. If the ambient temperature and output power are such that the UPS cannot otherwise maintain its specified maximum temperature for its internal circuitry, the fans will momentarily be driven at a speed that exceeds their rated long-term running speed. There is an LED on the front panel of the battery pack that indicates the speed of the fans.

If the ambient temperature is low enough (for the level of power being delivered to the load), the fans may not be on. This is not a malfunction. It is done to preserve the life of the fans. If the fans are off, check the Fan Service Required LED on the front panel of the battery pack. If it is GREEN, the fans are functioning properly and simply not needed under the present conditions.

The fans are weather-proof and water-proof.

The UPS has two fans to provide redundancy for these exposed, moving components. With only a single operating fan the UPS is still able to deliver 100% rated power at an ambient temperature as high as 40°C, and it is able to deliver 80% of its rated power at an ambient temperature as high as 55°C.





**Front Panel Indicators**

To indicate the status of the UPS and its battery pack, there is one LED above the ON/OFF switch on the left side of the front panel of the UPS and an additional 16 LEDs on the front panel of the battery pack. There is also an audible alarm. These indicators are described in this section.

**LEDs**

**LED above the ON/OFF switch**

This LED has four possible indications, according to the table below:

LED Appearance	Description	Indication
	Green	UPS is Running <i>(Outputs are Enabled)</i>
	Amber	UPS is on Standby <i>(Outputs are Enabled)</i>
	Red	UPS has a Fault Condition
	Off	UPS is Off



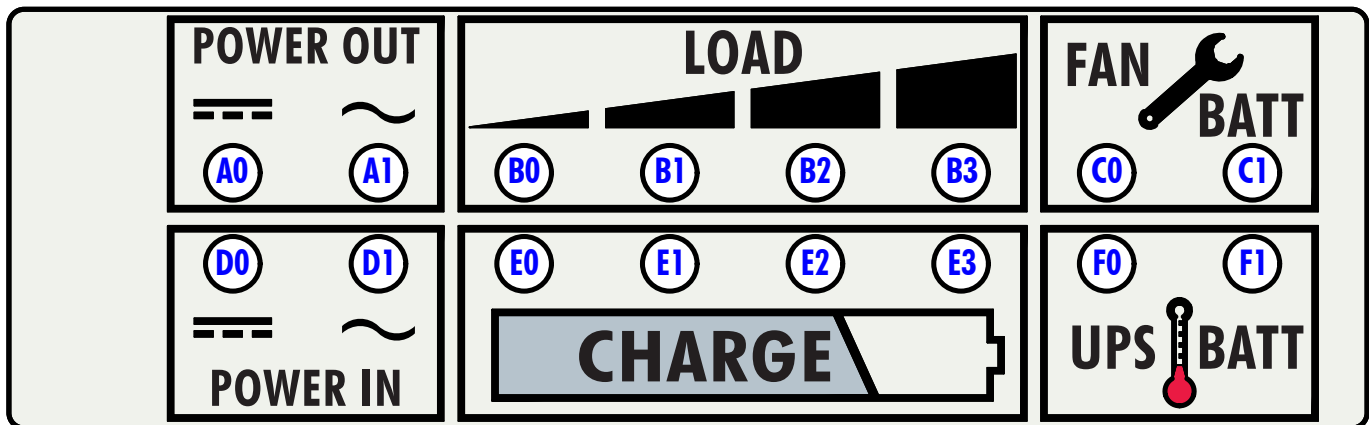

**LEDs on the Battery Pack**

Each battery pack has 16 LEDs, as shown below, that indicated the status of the battery pack and of the operation of the UPS. LED A1 is permanently disabled. There is no AC outlet on the unit.







**Power-In Indicators (LEDs in positions D0 and D1)**

The LED in position D0 indicates the status of the optional DC INPUT and the LED in position D1 indicates the status of the AC INPUT, according to the table below:

LED Appearance	Description	Indication
	<b>Green</b>	<i>Input is Ready to Provide Load Power</i>
	<b>Pulsing Green</b>	<i>Input is the One Presently Selected as the Source of Power</i>
	<b>Amber</b>	<i>Input has Returned within Range and Diagnostic Tests are Being Performed</i>
	<b>Off</b>	<i>Input is Not within Range</i>

**Power-Out Indicators (LEDs in positions A0 and A1)**

The LED in position A0 indicates the status of the DC OUTPUT, according to the table below:

LED Appearance	Description	Indication
	<b>Green</b>	<i>UPS is On and the Output Voltage is Within Range</i>
	<b>Amber</b>	<i>UPS is On but the Output Voltage is Out of Range</i>
	<b>Red</b>	<i>UPS is Off and the Output Voltage is Within Range</i>
	<b>Off</b>	<i>UPS is Off</i>

**Load Power Indicators (LEDs in positions B0 – B3)**

The LEDs in positions B0 through B3 indicate the output power of the UPS according to the table below:

LED Appearance	Description	Indication
	<i>B0 Dimmed Green; B1-B3 Off</i>	<i>Total Load Power &lt;25%</i>
	<i>B0 Green; B1 Dimmed Green; B2-B3 Off</i>	<i>Total Load Power &lt;50%</i>
	<i>B0, B1 Green; B2 Dimmed Green; B3 Off</i>	<i>Total Load Power &lt;75%</i>
	<i>B0, B1, B2 Green; B3 Dimmed Green</i>	<i>Total Load Power &lt;100%</i>
	<i>B0; B1; B2 Green; B3 Blinking Red</i>	<i>Total Load Power ≥100%</i>





**Battery State-of-Charge Indicators (LEDs in positions E0 – E3)**

The LEDs in positions E0 through E3 indicate the state-of-charge of the internal battery pack, as well as whether the battery pack is on standby or being charged (**Blinking Amber**) or discharged (**Blinking Red**), according to the table below.

LED Appearance			Indication
Standby	Discharging	Charging	
	NA	NA	<i>Battery Charge &lt;10%</i>
			<i>Battery Charge &lt;25%</i>
			<i>Battery Charge &gt;25%</i>
			<i>Battery Charge &gt;50%</i>
			<i>Battery Charge &gt;75%</i>
	NA	NA	<i>Battery Charge =100%</i>
	NA	NA	<i>Battery Charge =100% (Cell Balancing is Occurring)</i>





**UPS Cooling System Indicator (LED in position F0)**

The LED in position F0 indicates the temperature and status of the cooling system for the UPS according to the table below:

LED Appearance	Description	Indication
	<b>Green</b>	<i>Moderate UPS Temperature (Fans Running at 33%)</i>
	<b>Blinking Green</b>	<i>Warm UPS Temperature (Fans Running at 67%)</i>
	<b>Amber</b>	<i>Elevated UPS Temperature (Fans Running at 100%)</i>
	<b>Red</b>	<i>Maximum UPS Temperature (Fans Running at 110%)</i>



**Battery Pack Temperature Indicator (LED in position F1)**

The LED in position F1 indicates the temperature of the battery pack (and its availability to be charged or discharged because of its temperature) according to the table below:

LED Appearance	Description	Indication
	<b>Blinking Red</b>	<i>Battery is too Cold to be Charged or Discharged</i>
	<b>Blinking Amber</b>	<i>Battery is too Cold to be Charged</i>
	<b>Green</b>	<i>Battery Temperature is Within its Specified Operating Range</i>
	<b>Amber</b>	<i>Battery is too Hot to be Charged</i>
	<b>Red</b>	<i>Battery is too Hot to be Charged or Discharged</i>



**Fan Service Required Indicator (LED in position C0)**

The LED in position C0 indicates whether the two cooling fans in the rear panel of the UPS are OK or if their performance is degraded, according to the table below:

LED Appearance	Description	Indication
	<b>Green</b>	<i>Both Fans are OK</i>
	<b>Amber</b>	<i>One or Both Fans Have Recently Had Degraded Performance and Diagnostic Tests are Being Performed</i>
	<b>Red</b>	<i>One or Both Fans Presently Have Degraded Performance</i>

**Battery Pack Service Required Indicator (LED in position C1)**

The LED in position C1 indicates whether the battery pack is OK or if its storage capacity has been degraded compared to its rated value, according to the table below:

LED Appearance	Description	Indication
	<b>Green</b>	<i>Battery Pack is OK</i>
	<b>Amber</b>	<i>Battery Pack's Calculated Maximum Storage Capacity is &lt;75% of its Rated Value</i>
	<b>Red</b>	<i>Battery Pack's Calculated Maximum Storage Capacity is &lt;50% of its Rated Value</i>

### Audible alarm

For critical situations a pattern of audible tones will be repeated every 5 seconds, according to the table below. This audible alarm can be **silenced** by holding the ON/OFF switch on the front panel in the “UP” position until a chirp is heard. A new alarm condition will cause the audible alarm to be reactivated. Contact Factory for instructions on how to permanently silence the alarm.

Number of Tones in Pattern	Indication
One	<i>UPS is Drawing Power From the Battery Pack</i>
Two	<i>Load Power is greater than or approaching 100% Rated Power</i>
Three	<i>Fault Appears on the DC Output UPS Must be Turned Off and Back On to Reset Fault</i>
Four	<i>UPS is Drawing Power From the Battery Pack and the Remaining Charge is &lt;10%</i>

### Hot Swapping the Battery Pack

The battery pack can be removed from the UPS and it, or another one, can be inserted into the UPS without disrupting the delivery of power to the load as long as a source of input power is available. This feature is referred to as “hot swapping” in the industry. It can be used to replace a battery pack that needs servicing, or to replace a drained battery pack with a spare, fully charged one if additional back-up protection must be ensured before the drained battery pack will have time to be recharged.

Of course, if there is no source of input power available and the UPS is therefore drawing power from the battery, then the removal of the battery pack would cause the UPS’s outputs to shut down until a recharged battery pack is inserted.

### Operating Environment

The SynQor UPS-1250 DC Output Series is designed for the extreme environmental conditions of military and aerospace applications. All the electronic circuitry and the battery pack are contained in a sealed, weather-proof, shock-proof chamber constructed of die-cast aluminum. Only the redundant, water-proof cooling fans are exposed to the environment. Protection circuitry ensures that the battery is not charged or discharged if it is too hot or too cold. The UPS will shut down if it is too hot.

The UPS (with cables connected or connector covers installed and the battery pack installed) has been qualified to the following requirements of MIL-STD-810G:

MIL-STD-810G Test Method	Name	Procedure	Details
500.5	Low Pressure	I, II and III	<ul style="list-style-type: none"> <li>▪ 15,000 ft. operating</li> <li>▪ 40,000 ft. storage</li> </ul>
501.5	High Temperature	I and II	<ul style="list-style-type: none"> <li>▪ +55°C operating</li> <li>▪ +65°C storage</li> </ul>
502.5	Low Temperature	I and II	<ul style="list-style-type: none"> <li>▪ -20°C operating</li> <li>▪ -40°C storage</li> </ul>
503.5	Temperature Shock	I	<ul style="list-style-type: none"> <li>▪ 10 cycles; &gt;10°C/minute</li> </ul>
506.5	Rain	I	<ul style="list-style-type: none"> <li>▪ 4" rain/hour</li> <li>▪ 40 mph wind velocity</li> </ul>
507.5	Humidity	NA	<ul style="list-style-type: none"> <li>▪ &gt;95%</li> </ul>
508.6	Fungus	NA	<ul style="list-style-type: none"> <li>▪ 28 day test</li> </ul>
509.5	Salt Fog	NA	<ul style="list-style-type: none"> <li>▪ 5% salt solution</li> <li>▪ 2 cycles (24 hr wet/24 hr dry)</li> </ul>
510.5	Sand and Dust	I and II	<ul style="list-style-type: none"> <li>▪ 20 mph blowing dust</li> <li>▪ 40 mph blowing sand</li> </ul>
514.6	Vibration	Category 5	<ul style="list-style-type: none"> <li>▪ 5Hz (300 RPM)</li> <li>▪ Loose Cargo</li> </ul>
514.6	Vibration	Category 7	<ul style="list-style-type: none"> <li>▪ General Exposure</li> </ul>
514.6	Vibration	Category 8	<ul style="list-style-type: none"> <li>▪ C-130 Aircraft level</li> </ul>
514.6	Vibration	Category 9	<ul style="list-style-type: none"> <li>▪ General Exposure</li> </ul>
514.6	Vibration	Category 24	<ul style="list-style-type: none"> <li>▪ PSD = 0.04 g<sup>2</sup>/Hz; 20-2000 Hz</li> <li>▪ Operating</li> </ul>
516.6	Shock	I, IV and VI	<ul style="list-style-type: none"> <li>▪ 20 g/20 ms; 40 g/11 ms; 75 g/6 ms</li> <li>▪ 48 inch drop in transit case</li> <li>▪ 30 degree tilt and drop</li> </ul>
528	Mechanical Vibrations of Shipboard Equipment	I	<ul style="list-style-type: none"> <li>▪ Operating</li> </ul>



### Parallel Connection of DC OUTPUTS – Parallel Option

UPS units with the regulated paralleling option can be paralleled with the proper configuration cable. Each unit transmits its output current over the configuration cable, allowing every unit to calculate the average output current. The units then trim their output voltage slightly in an attempt to deliver the average output current.

Sharing is optimized when the output resistance is matched between all parallel units. The output cables should have the same construction, similar length, and be connected at a single point.

Parallel Unit Ordering Information		
	Regulation Type	Example PN
Regulated Output (No Paralleling)	-R	UPS-1250-S-1U-LR28D00-E00
Regulated Output with Paralleling	-P	UPS-1250-S-1U-LP28D00-E00

### N+M Redundancy - Ideal Diode

The ideal diode on the DC OUTPUT provides N+M redundancy when multiple units are placed in parallel. An N+M redundant system consists of N units to supply the maximum load, and M additional units to provide redundancy. Typically, one additional unit is used for redundancy giving “N+1 redundancy”.

During normal operation, all N+M units will deliver power to the load. Should one unit fail, the remaining units will increase their output current to continue to power the load. The failed unit can be removed and replaced to restore the redundancy level of the system to its original design. The replacement unit can be inserted into a live, operating system, but for safety reasons it is recommended that all units in the system be disabled first.

In addition to N+M redundancy, the ideal diode prevents power from flowing into the unit during normal operation. This ensures that power cannot circulate between multiple units when the outputs are in parallel. The digital communications ensures the load is shared evenly (-P ordering option).

### Configuration Cables

Configuration cables are necessary for paralleling. They provide the following features:

- Synchronized start up, shut down, and fault recovery
- Digital communication for load sharing
- Up to 32 units in parallel.

The table below lists configuration cables for systems of 2-5 units. Contact the factory for configuration cables that support more than five units in parallel.

<b>Configuration Cables for Paralleling</b>	
2 Units Parallel, 3'	SYN-9341
3 units parallel, 6'	SYN-9343
4 units parallel, 9'	SYN-9344
5 units parallel, 12'	SYN-9345

### ***On/Off control – Parallel Systems***

When several units are connected in parallel, any “on” front panel switch actuation will cause all outputs to turn on at once. In addition, the “remote-on” rear panel signal can be used for a coordinated start. Any “off” front panel switch actuation will cause that specific unit be turned off. All other units will continue to deliver power, assuming the load can be supported with one less unit. In addition, the “remote-on” or “remote-off” rear panel signal inputs may be utilized to enable and disable one specific unit.

For coordinated shutdown, the user must send “SYSTEM DISABLE” over RS-232. See Section V of the Owner’s guide for details on the RS-232 interface. See the UPS User Commands document for more information on the “SYSTEM DISABLE” command.

### ***Connection of the AC INPUTS and/or DC INPUTS***

There are several ways that the AC and/or DC INPUTS can be connected to sources of power:

- They could be connected to the same AC and/or DC source, respectively.
- They could be connected to different AC and/or DC sources, respectively.

All that is necessary is to ensure that the input voltage falls within the specified range of the AC and/or DC INPUTS of the individual UPS units.

Furthermore, the individual AC INPUT and/or DC INPUT cables can be first combined into a single cable (of appropriate minimum wire size), or they can be left as separate cables, each connected to the desired AC or DC source.

Note that the UPS input circuit breaker disconnects the unit from the AC input bus should a UPS experience a hardware fault on its input stage.

---

### ***3-Phase AC INPUT Source***

---

When three UPS units are used (with their DC OUTPUTS connected in parallel), each UPS unit's AC INPUT can be connected to a different phase of a 3-Phase source. There are two different ways to do this:

- each UPS unit's AC INPUT can be connected from a line (i.e., L1 or L2 or L3) of the AC source to the neutral wire of the AC source (assuming it is present), or
- each UPS unit's AC INPUT can be connected from one line of the AC source to another (i.e., L1 to L2, L2 to L3, or L3 to L1)

Either connection scheme is acceptable, as long as the resultant input voltage falls within the specified range of the AC INPUT of the individual UPS units.

If the UPS units are parallel models and the DC OUTPUTS are connected in parallel, they will automatically share the total load power equally. Therefore, the power that they each draw from their respective AC INPUT phases will be balanced with each other. If, on the other hand, the three UPS units are regulated output models, the DC OUTPUTS cannot be directly paralleled. The power flowing through each UPS, and therefore the power drawn from each AC INPUT phase, will depend on the load power drawn from each DC OUTPUT. This load power may or may not be balanced.

## Battery Technology

The battery packs for the UPS-1250 Series contain Lithium Ion rechargeable batteries. For a given amount of energy storage they are much smaller and lighter than a lead-acid battery. They are capable of very high discharge rates and fast recharging, and can do so over many cycles and over a long life. As such they are very suitable for a UPS application. Lithium Ion batteries are used in many military applications.

## Electronic Circuitry within the Battery Pack

The SynQor battery pack has electronic circuitry within it that:

- controls the charging (including the equalization charging) of the battery
- separates the battery cells into multiple segments
- provides protection of the battery
- runs diagnostics on the battery
- controls the battery pack's front panel LED indicators

The purpose of separating the battery cells into multiple segments is to allow the battery pack to remain useful even if one of its battery cells fails. In a normal battery configuration, the failure of a single cell would disable the entire battery. The SynQor battery packs are designed with their battery cells arranged in segments that can be disconnected from the other segments by the internal electronic circuitry. Therefore, if a battery cell fails in one segment, the battery pack can still operate with the remaining segments (at a reduced battery run-time) until the battery pack can be serviced.

There are two battery packs offered for the SynQor UPS products: BAT-0200 and BAT-0400. These packs have 3 and 4 battery segments, respectively. The BAT-0200 and BAT-0400 batteries are applicable to the UPS-1250-[S,H,M]-[1U,2S], UPS-1500-[S,H,M]-[1U,2S], UPS-3000-[S,H,M]-2U devices.

The protection features provided by the electronic circuitry include:

- **Maximum Current Limit** when the battery is being charged/discharged
- **Charging/Discharging Protections** to avoid over-charging/discharging of the battery
- **Charging/Discharging Lockout** if the battery is too hot or too cold
- **Disconnect** of the battery from the battery pack's terminals when the pack is not inserted into the UPS

**Battery Capacity**

SynQor offers multiple battery packs in a sub-1U high form factor, the BAT-0200 and the BAT-0400. The BAT-0200 weighs 10 lbs. and has 3 battery segments. The BAT-0400 weighs 11.8 lbs. and has 4 battery segments. All battery packs will recharge in about two hours. The run-time as a function of UPS load power is shown on the below table.



Total UPS Output Power	BAT-0200 Run-Time	BAT-0400-H Run-Time	BAT-0400-M Run-Time
100% Rated Power	> 10 Minutes	> 13.5 Minutes	> 16 Minutes
80% Rated Power	> 13 Minutes	> 18 Minutes	> 22 Minutes
60% Rated Power	> 21 Minutes	> 27 Minutes	> 34 Minutes

**Storage of the Battery Pack**

The storage temperature range of the battery pack (whether it is inserted in the UPS or stored separately) is -40°C to +65°C (-40°F to +150°F). Long term storage outside this temperature range will lead to a permanent reduction in the battery’s energy storage capacity. The optimal storage temperature is below 35°C. Storage above this temperature will accelerate battery degradation.

**Battery Pack Replacement**

UPS-1250-S-1U and UPS-1500-S-1U products ship with the BAT-0200 battery pack. UPS-1250-H-1U and UPS-1500-H-1U products ship with the BAT-0400-H battery pack. UPS-1250-M-1U and UPS-1500-M-1U products ship with the BAT-0400-M battery pack. However, the three packs are interchangeable; for example, a BAT-0400-M battery may be installed in an existing UPS-1500-S-1U device as an upgrade to the performance. The table below shows the applicable battery packs for various series of SynQor UPS devices. Always use the proper SynQor battery pack.

UPS Series	BAT-0200	BAT-0400-%
UPS-1250-[S,H,M]-[1U,2S]	Qty. 1	Qty. 1
UPS-1500-[S,H,M]-[1U,2S]	Qty. 1	Qty. 1
UPS-3000-[S,H,M]-2U	Qty. 2	Qty. 2

### Handling the Battery Pack

The operating temperature range of the battery pack is -20°C to +55°C (-4°F to +130°F). The battery pack's internal electronic circuitry will disable the battery if the cell temperatures are outside this temperature range. The SynQor UPS is equipped with internal battery heaters which activate to keep the cells above 0°C in cold ambient temperatures. Therefore, the UPS can be used at ambient temperatures as low as -40°C when input power is available to operate the battery heaters.

Additionally, the BAT-0400-M pack has the capability of powering the battery heaters from internal battery energy. This enables coldstart operation down to an ambient temperature as low as -40°C. During coldstart self-heat, the battery heaters run in a high power mode capable of bringing the battery to operational temperature in about 3.5 minutes.

When the battery pack is not inserted into the UPS, the internal electronic circuitry disconnects the battery from the pack's power terminals. Nevertheless, care should be taken to avoid making metal contact with (or between) any of these terminals.

The battery pack has its own aluminum chassis that protects its battery cells and internal electronic circuitry from the environment when the pack is not inserted into the UPS. However, care should be taken to ensure this chassis and the exposed power terminal strip is not subjected to extreme mechanical shock or to excessive moisture.

UPS battery packs must be shipped per Federal DOT Regulations as a Class 9 Fully Regulated Hazardous Material. The battery pack must not be installed in the UPS when being shipped, and it must be packaged in the original SynQor Shipping Carton (including inner protective inserts) which has been approved for shipping this product. The shipping carton must be appropriately labeled per applicable Federal DOT Requirements. A UPS may be shipped using standard shipping methods if it does not contain a battery pack. Please contact SynQor for further assistance.

The battery pack should be disposed in accordance with applicable regulations of the locality or returned to a factory-authorized Service Center.

Emergency response contact information for battery damage, leaks, smoke, or fires can be found at the following link: <http://www.SynQor.com/UPS/documents/Contact.pdf>. Please contact the SynQor factory for all other questions regarding the UPS battery pack.

**CAUTION:** Do not dispose of batteries in a fire. The batteries may explode.

**CAUTION:** Do not open or mutilate batteries. Released electrolyte is harmful to the skin and eyes. It may be toxic.

Always use the proper SynQor battery pack. See the battery replacement chart on page 37.

### Control Cable Connections

There are two high-density (three-row) DB15 connectors located on the rear panel of the UPS:

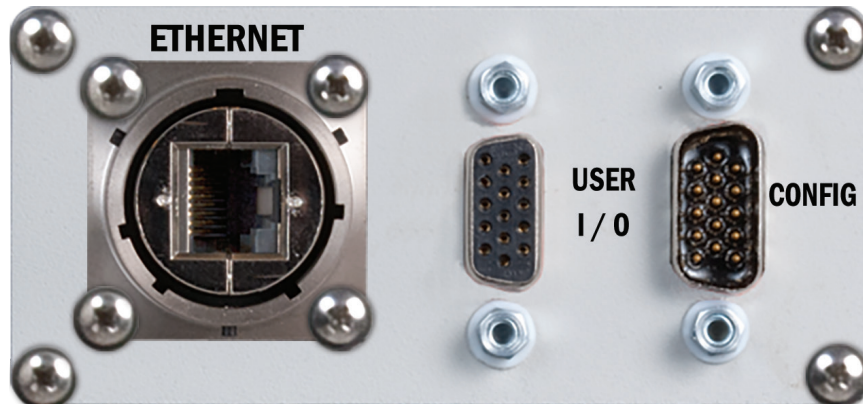

The User I/O female DB15 connector on the left is for a connection to a host/system computer so that it can control the UPS and receive information regarding the status of the UPS.

The Configuration male DB15 connector on the right is used to parallel multiple units. Use the appropriate configuration cable as described in Section IV

The designation/location of the pins for the User I/O female high-density DB15 connector is shown below:



**Internal User I/O Circuits**

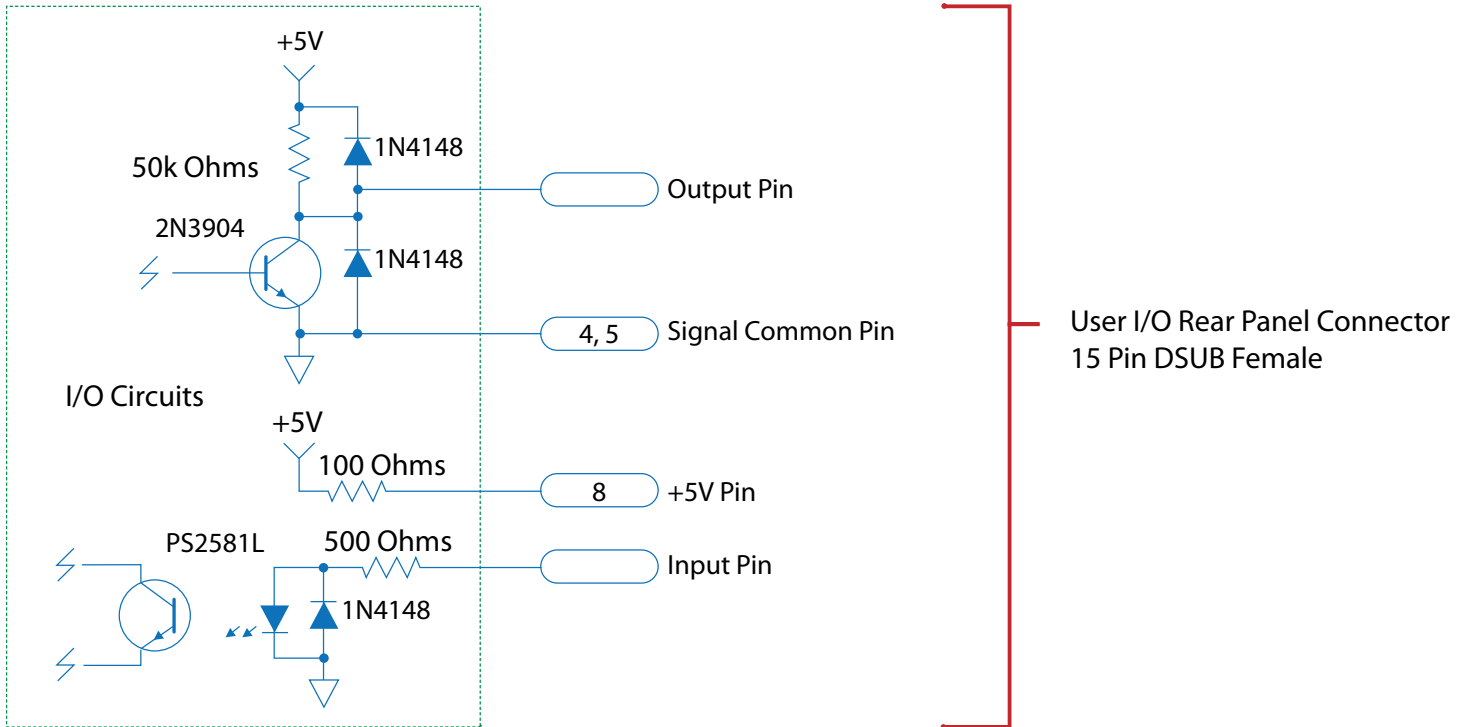

**Remote On/Off Switch Connections**

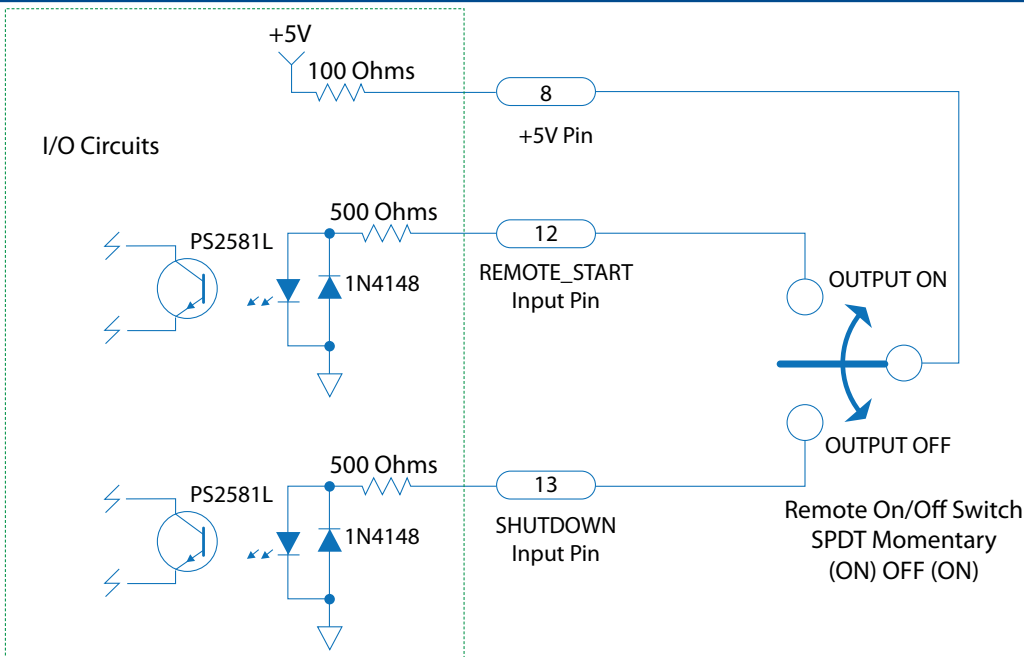

Note: A 2PDT or 3PDT switch may be substituted for single control of 2 or 3 UPS machines, respectively.



### Digital Input/Output Control Signals

There are 2 input and 5 output digital signals available on the User I/O female high-density DB15 connector. The pin assignments and functions of these digital I/O signals are as follows:

Signal	Pin Number	Function
+5 V	8	Bias voltage with minimal current drive usable as a pull-up voltage for the open collector output signals (100Ω source resistance)
GND	4 and 5	Ground reference for all digital inputs and outputs
$\overline{\text{LOW\_BATT}}$	6	Open collector* output where “low” indicates battery charge level is <10%
$\overline{\text{ACIN\_GOOD}}$	7	Open collector* output where “low” indicates AC Input voltage is within range
$\overline{\text{ON\_BATT}}$	9	Open collector* output where “low” indicates the UPS is drawing power from its battery
$\overline{\text{OUT\_OK}}$	14	Open collector* output where “low” indicates DC Output voltage is within range
$\overline{\text{OVER\_TEMP}}$	15	Open collector* output where “low” indicates that the UPS is at or above its maximum temperature
REMOTE_START	12	Drive this line “high” with $\geq 5\text{mA}$ to enable the UPS outputs
SHUTDOWN	13	Drive this line “high” with $\geq 5\text{mA}$ to disable the UPS outputs

\*with an internal 50 kΩ Pull-up Resistor to 5 V and ESD Protection Diodes.

### RS232 Serial Interface

The same User I/O female high-density DB15 connector also provides for an RS232 interface between the UPS and the host/system computer. The interface has a 115.2k baud with eight data bits, no parity bit and one stop bit. The pin assignments and functions for this RS232 interface are as follows:

Signal	Pin Number	Function
GND	4 and 5	Ground reference for RX and TX signals
RX	3	RS232 DCE/UPS Device Receive signal
TX	2	RS232 DCE/UPS Device Transmit signal

The RS232 port provides readback of UPS’s state, as well as the configuration and control of the UPS’s operation. The port can be used from a standard terminal interface, or from a custom computer application.

***Readback information that is available:***

- AC Input Voltage
- AC Input Current
- AC Input Frequency
- DC Input Voltage
- DC Output Power
- Total Output Power
- Battery Voltage
- Battery State of Charge
- Battery Predicted Run Time
- Number of Battery Cycles
- External Switch Input Status
- Fan RPM
- Internal Temperatures

***Parameters that are controllable through the interface:***

- Output enable / disable
- Fan diagnostics
- Alarm enable / disable

For a detailed description of the terminal interface see the SynQor website at:  
[http://www.SynQor.com/UPS/documents/UPS\\_User\\_Commands.pdf](http://www.SynQor.com/UPS/documents/UPS_User_Commands.pdf)

## *Ethernet Interface*

The Ethernet interface provides a web page based user interface for monitoring and control of the UPS. The user can configure email alerts for UPS alarm conditions. The interface also exposes an SNMP interface compliant to RFC-1628.

The Ethernet interface supports 10BASE-T and 100BASE-T standards. It utilizes a standard RJ-45 connector, also allowing a metallic sealable circular military outer housing. The interface supports auto-negotiation, polarity correction, and Auto-MDIX (detection and use of straight through or cross-over cables).

IP address assignment can be done via DHCP or user entry of a static address. The interface also supports a direct connection between the UPS and a host computer by including a DHCP server internal to the UPS.

For a detailed description of the Ethernet port and SNMP implementation see the SynQor website. [http://www.synqor.com/ups/documents/UPS\\_Ethernet\\_SNMP\\_UG.pdf](http://www.synqor.com/ups/documents/UPS_Ethernet_SNMP_UG.pdf)

## Battery

The lithium ion battery cells in the battery pack do not need any maintenance. In particular, unlike a lead acid battery a lithium ion battery does not need to re-charged on a regular basis to avoid degradation of its energy storage capacity. Care should only be taken to ensure that they are not stored at a temperature outside their specified storage temperature range of -40°C to +65°C (-40°F to +150°F).

Emergency response contact information for battery damage, leaks, smoke, or fires can be found at the following link.

<http://www.SynQor.com/UPS/documents/Contact.pdf>

Please contact the SynQor factory for all other questions regarding the UPS battery pack.

**CAUTION:** Do not dispose of batteries in a fire. The batteries may explode.

**CAUTION:** Do not open or mutilate batteries. Released electrolyte is harmful to the skin and eyes. It may be toxic.

Always use the proper SynQor battery pack. See the battery replacement chart on page 37.

## Fans

The fans on the rear panel have sealed bearings that do not require any maintenance. Fan assemblies are user replaceable with kits available from SynQor. Please contact the SynQor factory for obtaining fan replacement kits.

## Cleaning

The UPS-1250 unit has a sealed chamber for its electronics and the battery pack that is weather-proof. Only the fans on the rear panel are exposed to the environment, and these fans are also weather-proof. The unit can therefore be cleaned without concern of getting liquids inside the chamber. **NOTE**, however, that if the cables have been removed from the connectors the connectors should have their covers installed. If they are not, then care should be taken to not get excess liquid on the connector terminals. **ALSO NOTE** that care should be taken to not get excess liquid on the switch of the AC BREAKER on the back panel.

Cleaning should be done either with soap and water or with an Isopropyl alcohol and water mixture. A soft cloth should be used.

Do not immerse the unit in water to clean it.

**Fault Conditions**

The SynQor UPS has no user-serviceable parts within it (other than the fans). If it has an internal malfunction only a factory trained personnel should attempt to repair it.

There are, however, several external conditions that could cause the UPS to not operate as desired. These external conditions can likely be corrected by the user.

The 16 LEDs on the front panel of the battery pack are the best and first place to look to determine what might be wrong with the UPS. The table on the next several pages is therefore organized by what these LEDs indicate, and for each indication there is a listing of what might possibly be wrong.

The front panel battery pack LED array is shown below. The designations of the 16 LEDs in this array are used in the following table.

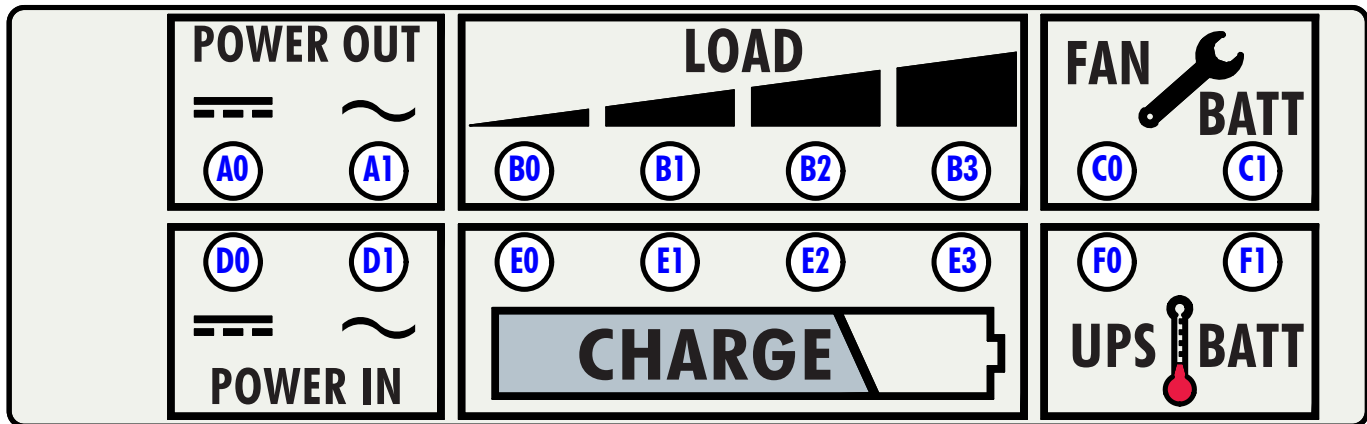

LED	Indication	Possible Problem(s)
<b>D1: AC INPUT Power LED</b>	LED is OFF	<ul style="list-style-type: none"> <li>•The AC INPUT power source is not turned on.</li> <li>•The AC INPUT cable is not connected or it is wired wrong.</li> <li>•The AC Breaker on the rear panel is OFF.</li> <li>•The AC INPUT voltage is either too low or too high.</li> </ul>
	LED is a STEADY GREEN and not a PULSING GREEN.  UPS is instead running off the optional DC INPUT or the BATTERY	<ul style="list-style-type: none"> <li>•The AC INPUT voltage is within its proper range but the UPS is not selecting it for its source of power.</li> <li>•The AC INPUT voltage and the total load power may exceed the power derating curves given earlier in this Guide.</li> <li>•The AC INPUT cable may have too much series resistance. Thicker wire should be used.</li> </ul>
<b>D0: DC INPUT Power LED</b>	LED is OFF	<ul style="list-style-type: none"> <li>•The optional DC INPUT is not available on this unit.</li> <li>•The DC INPUT power source is not turned on.</li> <li>•The DC INPUT cable is not connected or it is wired wrong.</li> <li>•The DC INPUT cable is connected to the DC source with the wrong polarity.</li> <li>•The DC INPUT voltage is either too low or too high</li> <li>•The DC INPUT cable may have too much series resistance. Thicker wire should be used.</li> </ul>
<b>A0: DC OUTPUT Power LED</b>	LED is OFF	<ul style="list-style-type: none"> <li>•The UPS is OFF and needs to be turned ON.</li> </ul>
	LED is AMBER	<ul style="list-style-type: none"> <li>•The DC Output load is higher than 1250 W.</li> <li>•The DC Output is shorted within the cable or a load.</li> <li>•Some other source of power is connected to the DC OUTPUT.</li> </ul>

LED	Indication	Possible Problem(s)
<b>B0 – B3: LOAD POWER LEDs</b>	B3 is BLINKING RED	<ul style="list-style-type: none"> <li>• Total UPS load power is greater than or approaching 1250 W. The UPS may still be delivering its specified output voltage because the load power is not high enough to trigger the power limit circuitry.</li> </ul>
	B0 – B3 are all OFF	<ul style="list-style-type: none"> <li>• No power is being delivered to the load.</li> <li>• The UPS is OFF and needs to be turned ON.</li> <li>• The loads or output cables are not connected.</li> <li>• The loads are all turned off.</li> <li>• The loads are simply not drawing any appreciable power at the time.</li> </ul>
<b>F0: UPS Cooling System LED</b>	LED is BLINKING GREEN	<ul style="list-style-type: none"> <li>• Indicates that the fans are running at 67% of their rated speed. There is no problem.</li> </ul>
	LED is AMBER	<ul style="list-style-type: none"> <li>• Indicates that the fans are running at 100% of their rated speed. There is no problem, but the unit is operating at a high ambient temperature and a high load combination.</li> </ul>
	LED is RED	<ul style="list-style-type: none"> <li>• Fans are running at 110% of rated speed to keep the unit cool. The maximum recommended temperature may be exceeded, but the fans are keeping things cool enough to avoid triggering the over-temperature shut-down circuitry.</li> </ul>
<b>F1: Battery Pack Temperature LED</b>	LED is BLINKING RED	<ul style="list-style-type: none"> <li>• The battery is too cold to be charged or discharged without damage.</li> <li>• If the UPS is running from the AC INPUT or the DC INPUT the battery will eventually be warmed up and this condition will go away.</li> </ul>
	LED is BLINKING AMBER	<ul style="list-style-type: none"> <li>• The battery is too cold to be charged without damage, but it can be discharged if the UPS needs to draw power from it.</li> <li>• If the UPS is running from the AC INPUT, the DC INPUT or the battery, the battery will eventually be warmed up and this condition will go away.</li> </ul>
	LED is STEADY AMBER	<ul style="list-style-type: none"> <li>• The battery is too hot to be charged without damage, but it can be discharged if the UPS needs to draw power from it.</li> <li>• If the ambient temperature is within its specified range the battery will eventually cool down and this condition will go away.</li> </ul>
	LED is STEADY RED	<ul style="list-style-type: none"> <li>• The battery is too hot to be charged or discharged without damage.</li> <li>• If the ambient temperature is within its specified range the battery will eventually cool down and this condition will go away.</li> </ul>

LED	Indication	Possible Problem(s)
<b>C0:</b> Fan Service Required LED	LED is AMBER	<ul style="list-style-type: none"> <li>•One or both fans have recently had degraded performance but seem to be ok now. The UPS is running a diagnostic test.</li> </ul>
	LED is RED	<ul style="list-style-type: none"> <li>•One or both fans presently have degraded performance, even if they are running, and service is recommended at the earliest convenient time.</li> <li>•Ensure that the fan blades are not obstructed from turning</li> </ul>
<b>C1:</b> Battery Pack Service Required LED	LED is AMBER	<ul style="list-style-type: none"> <li>•The battery pack's calculated maximum energy storage capacitor is &lt;75% of its rated value. The UPS's battery run-time will therefore be similarly reduced.</li> <li>•The battery pack should be replaced at the earliest convenient time if this derated battery run-time is unacceptable.</li> </ul>
	LED is RED	<ul style="list-style-type: none"> <li>•The battery pack's calculated maximum energy storage capacitor is &lt;50% of its rated value. The UPS's battery run-time will therefore be similarly reduced.</li> <li>•The battery pack should be replaced at the earliest convenient time.</li> </ul>
<b>All 16 LEDs:</b>	All LEDs are OFF	<ul style="list-style-type: none"> <li>•The battery pack is not fully inserted into the UPS with its thumb screws tightened.</li> <li>•The terminal on the battery pack is damaged or dirty.</li> <li>•The battery pack is defective and needs to be replaced.</li> </ul>
<b>Audible Alarm:</b> (pattern repeats every 5 seconds)	One tone	<ul style="list-style-type: none"> <li>•The UPS is drawing power from the battery pack and is discharging it.</li> <li>•Sources of power should be restored or preparations made to shut down the loads</li> </ul>
	Two tones	<ul style="list-style-type: none"> <li>•The total UPS load power is above 1250 W.</li> <li>•Loads should be reduced if this condition persists.</li> </ul>
	Three tones	<ul style="list-style-type: none"> <li>•The DC OUTPUT has experienced a short circuit or a load having a start-up surge characteristic that the UPS could not start. The DC OUTPUT is in hiccup mode.</li> <li>•To reset the DC OUTPUT, turn the unit OFF. Clear the short circuit fault on the end-use equipment. Turn the unit back ON.</li> </ul>
	Four tones	<ul style="list-style-type: none"> <li>•The UPS is drawing power from the battery pack and its remaining charge is &lt;10% of its rated charge.</li> <li>•Sources of input power should be restored or the loads should be shut down.</li> </ul>



***Two other conditions should be mentioned:***

- The fans are off when the UPS is running

It is normal for the fans to be off, even if the UPS is running and delivering power to the load, as long as the temperature of the UPS is low enough. If the Fan Service Required LED (C0) is green, both of the fans are OK, even if they are not running.

- The UPS does not turn off when the ON/OFF switch is pushed down

When the ON/OFF switch on the front panel is pushed down, the UPS does not respond to this signal for approximately 1 second. This is done to ensure that the UPS is not accidentally turned off. If the user does not hold the ON/OFF switch in the OFF position for a full second before releasing it, the UPS will not turn off.

***Other possible situations that are the result of external issues that a user could likely correct are related to:***

- Loads that draw a large surge of current at start-up

Some DC loads draw a very large amount of current when an input voltage is first applied to them. This might happen when the UPS is first turned on if the load is already connected to the UPS. Or it may happen when the load itself is turned on and/or connected to the DC OUTPUT of a UPS that is already running. Common examples of such loads are motors and incandescent lights, but some electronic equipment can also display this characteristic.

Several problems could arise with such a load:

- The UPS fails to start the load:

The SynQor UPS is designed to try various start-up routines when it is first turned on to overcome the problem of surge currents with some loads.

If there is more than one load of the DC OUTPUT that displays this start-up surge characteristic, and the UPS is not capable of starting with all of them connected and switched on, it may be possible to switch on each load in turn. For instance, if the UPS cannot start up with a load consisting of a large bank of incandescent lights, then it may be able to start if various sections of the lights are switched on in sequence.

- A newly started load disturbs the existing UPS loads.

A common problem can occur when the UPS is running and powering one or more loads connected to its DC OUTPUT, and then an additional load of the DC OUTPUT is turned on. If this newly started load draws a large surge current at start-up, it can cause the current limit of the UPS's DC OUTPUT to be triggered, and the DC OUTPUT voltage will then drop. This drop could cause the existing loads to be disturbed. Furthermore, if the voltage drops far enough, the UPS will turn off its DC OUTPUT and initiate a new start-up sequence (after 4 seconds). This latter action would cause the power flow to the existing loads to be interrupted.

If this disruption of existing loads is a problem, then the solution is to make sure the loads that display this start-up surge characteristic are all started first, or that all loads are started at the same time.

- Cable wire resistance is too high:

As mentioned in the section "Power Cables Wire Size", the resistance of a power cable's wires gives a voltage drop from the upstream to the downstream end of the cable. This voltage drop, if large enough, will cause the either UPS to determine that the voltage at its AC INPUT or its DC INPUT is below its minimum specified value, even though the corresponding voltage at the source of AC or DC power is within the specified range.

This problem is particularly possible for the DC INPUT, since the DC INPUT current is so high (as much as 65 A at full power) and the DC INPUT voltage is so low (as low as 22 V).

The phenomenon that may be displayed is the following.

- Assume the AC INPUT source is not present, but the DC INPUT source is.
- The UPS, before it turns on, does not draw any power or current from the DC INPUT, and therefore the voltage drop across the DC INPUT cable is zero.
- The UPS sees that the voltage at the DC INPUT is within its specified range, and enables its outputs.
- As the load then draws power, the UPS begins to draw current from the DC INPUT cable. This current causes a voltage drop to appear across the cable.
- If the voltage at the DC source is close to, but still above, its 22 V minimum, but the voltage drop across the cable is large enough for the voltage at the DC INPUT of the UPS to fall below 22 V, then the UPS will determine that the DC INPUT is out of range and will switch over to drawing power from the internal Battery Pack.
- Since the UPS no longer draws current from the DC INPUT, the voltage drop across the DC INPUT cable goes back to zero volts.
- After a while, the UPS decides the DC INPUT voltage is back within its proper range, and begins to draw a current from the DC INPUT.

- The cycle above repeats itself for a total of three times, at which point the UPS stops trying to draw power from the DC INPUT for one minute. After this one minute another set of 3 cycles are repeated, followed by another stop for one minute, and so on.

This same problem can also occur for the AC INPUT if the voltage at the AC source is close to the specified 80 Vrms minimum limit. In this case the UPS will try ten times before stopping for a one minute interval.

The solution to this problem is to make sure that the cable has wires of sufficient diameter, or “gauge” for the length of the cable. The longer the cable, the bigger diameter the wire should have.

See the section “Power Cable Wire Size” for recommended cable wire sizes.

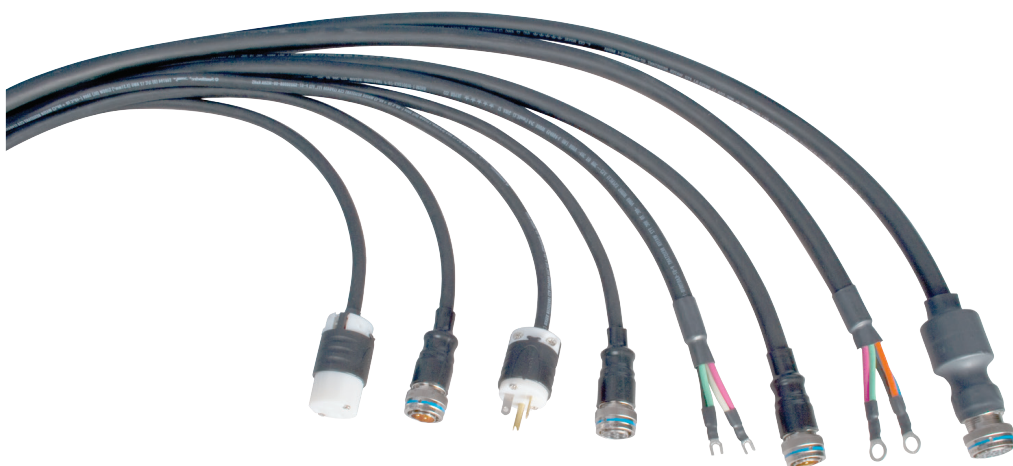

# UPS **MILITARY FIELD-GRADE**

UNINTERRUPTIBLE POWER SUPPLY

## Operator's Guide *UPS-1250 DC Output Series*



Made in USA

006-0007097

09/12/2023

REV K

**SynQor**<sup>®</sup>  
Advancing The Power Curve<sup>®</sup>